

# Read This First

## Operating Instructions

**1** Setting up your  
CLIE™ handheld

**2** Basic operations of your  
CLIE™ handheld

**3** Connecting to the  
Internet

**4** Have a try  
Taking pictures / Recording  
movies  
Recording a voice memo  
Listening to music  
Managing schedule events /  
addresses  
Viewing computer documents  
Using the Bluetooth®  
function

**CLIE™ handheld  
components**

Personal Entertainment Organizer

**PEG-UX50**  
**PEG-UX40**

**CLIE™**

© 2003 Sony Corporation

 **Bluetooth®**



**MEMORY STICK**

The following manuals are included with your CLIÉ handheld.  
Refer to the following together with this manual.

**Before you start using your CLIÉ handheld (This manual)**

**Read This First (Operating Instructions)**

Explains the following:

- Setting up your CLIÉ handheld and computer
- Basic operations
- What you can do with the applications

**For safe use, be sure to read the supplied “Safety & Regulations Guide”.**



- When you want to become more familiar with the basic operations of your CLIÉ handheld
- When you want to change the settings of your CLIÉ handheld

**Handbook**

**Using CLIÉ handheld for the first time**

The basic features and operations are explained in detail.

**CLIÉ handheld advanced operations**

Useful and advanced features of your CLIÉ handheld are explained in detail.

- When you want to become more familiar with using the supplied applications
- When you want to install additional applications

**CLIÉ Application Manual (HTML format: Read via a computer window)**

Explains how to use the supplied applications in detail.

**CLIÉ Application Manual will be automatically installed on your computer when you install Palm™ Desktop for CLIÉ.**

For details on using the manual, refer to “Using the CLIÉ Application Manual” on page 72 of this manual.

- If you have problems

**Troubleshooting Q&A**

Helps in solving common problems that you may have while using your CLIÉ handheld.

# Before use

## Caution

IN NO EVENT SHALL SONY BE LIABLE FOR ANY INCIDENTAL, INDIRECT OR CONSEQUENTIAL DAMAGES OR OTHER DAMAGES INCLUDING WITHOUT LIMITATION LOSS OF PROFITS, LOSS OF REVENUE, LOSS OF DATA, LOSS OF USE OF THE PRODUCT OR ANY ASSOCIATED EQUIPMENT, DOWNTIME, AND PURCHASER'S TIME RELATED TO OR ARISING OUT OF THE USE OF THIS PRODUCT, ITS HARDWARE AND/OR ITS SOFTWARE.

## CAUTION

Please contact with your nearest Sony dealer in connection with the product with problem.

## On the supplied software

- Copyright laws prohibit reproducing the software or the software manual in whole or in part or renting the software without the permission of the copyright holder.
- In no event will SONY be liable for any financial damage or loss of profits, including claims made by third parties, arising out of the use of the software supplied with this product.
- In the event a problem occurs with this software as a result of defective manufacturing, SONY will replace it at SONY's option or issue a refund. However, SONY bears no other responsibility.
- The software provided with this product cannot be used with equipment other than that which it is designated for use with.
- Please note that, due to continued efforts to improve quality, the software specifications may be changed without notice.
- The software library incorporated in the CLIE handheld is based in part on the work of the Independent JPEG Group.

## NOTES

- Sony does not support third party add-on applications. If you have a problem with a third party application, please contact the developer or publisher of that software.
- The illustrations in this manual may differ from the actual software.
- Explanations in this manual assume that you are familiar with basic operations of Windows®. For how to use your computer and operating system, please refer to their respective manuals.

Program © 2003 Sony Corporation, © 2003 PalmSource, Inc., or its subsidiaries. All rights reserved.

Documentation © 2003 Sony Corporation

# Table of Contents

## Setting up your CLIÉ™ handheld

**Confirming the package contents . . . . . 6**

**Setting up your CLIÉ™ handheld . . . . . 8**

Step 1: Charging your CLIÉ handheld . . . . . 8  
Step 2: Performing the initial setup after turning on your CLIÉ handheld for the first time . . . . . 9

**Using your CLIÉ™ handheld with your computer . . . . . 16**

Step 1: Installing the software on your computer . . . . . 16  
Step 2: Connecting your CLIÉ handheld and computer via the USB cable . . . . . 19  
Step 3: Entering a user name for your CLIÉ handheld . . . . . 20  
Synchronizing data between your CLIÉ handheld and computer (the HotSync® operation) . . . . . 21

## Basic operations of your CLIÉ™ handheld

**Turning on/off your CLIÉ™ handheld . . . . . 24**

Turning on your CLIÉ handheld . . . . . 24

**Starting an application . . . . . 25**

Using the Jog Dial™ navigator and the BACK button . . . . . 25  
Other ways to start an application . . . . . 27

**About Internal Media . . . . . 28**

**Entering text. . . . . 29**

**Turning off your CLIÉ™ handheld using Power Saving Mode . . . . . 30**

Turning off your CLIÉ handheld (Power Saving Mode). . . . . 30

**Restarting your CLIÉ™ handheld . . 32**

## Connecting to the Internet

**Preparing for the wireless LAN function . . . . . 35**

Step 1: Verifying the settings for the wireless LAN access point. . . . . 36  
Step 2: Preparing the check sheet . . . . . 37  
Step 3: Setting up the wireless LAN function . . . . . 38

**Browsing websites. . . . . 40**

Setting up NetFront v3.0 for CLIÉ . . . . . 40  
Browsing websites by connecting to the Internet via the wireless LAN access point. . . . . 42

**Sending/Receiving e-mail messages . . . . . 43**

Setting up CLIÉ Mail . . . . . 43  
Sending e-mail messages . . . . . 45  
Receiving e-mail messages . . . . . 46

## Have a try

Enjoying image files. . . . . 47  
Enjoying movies . . . . . 50  
Recording a voice memo (Voice Recorder). . . . . 53

Viewing handwritten memos and image files, and playing back voice memos . . . . . 55  
Listening to music . . . . . 57  
Managing schedule events (Date Book). . . . . 59  
Managing addresses and telephone numbers (Address Book) . . . . . 61

Exchanging Date Book and Address Book data between your CLIÉ handheld and computer. . . . . 63  
Viewing computer documents on your CLIÉ handheld (PicSel Viewer for CLIÉ) . . . . . 64  
Using the Bluetooth® function. . . . . 66

**Using applications. . . . . 72**

Using the CLIÉ Application Manual . . . . . 72  
Introducing applications . . . . . 74

## **Additional information . . . . . 85**

Making a backup of the data or applications on your CLIE handheld . . . . .	85
Resetting your CLIE handheld to the factory setting . . . . .	86
Troubleshooting . . . . .	87
Customer Support and Customer Registration . . . . .	88
Notes on use . . . . .	89
Specifications . . . . .	93

## **CLIE™ handheld components**

Front panel . . . . .	98
Back panel . . . . .	100
Locating the components of the CLIE 3D Launcher . . . . .	106
Locating Charger Cradle components . . . . .	111
<b>INDEX . . . . .</b>	<b>112</b>

---

## **Notes on this manual**

- This manual supports PEG-UX50 and PEG-UX40.
  - The illustrations in this manual are for PEG-UX50, unless specified otherwise.
  - Differences between PEG-UX50 and PEG-UX40 are specified in each corresponding section.
- Screen shots in this manual may be different from the actual displays in the supplied software.
- The contents of this manual are written for users with a working knowledge of Windows®. For details on computer operations, refer to your computer manual.

## **LCD display and camera lens**

The LCD of your CLIE handheld is designed with precision technology. However, in some cases, individual pixels may remain lit or may not light at all. Also, the brightness of the display may appear inconsistent, depending on the angle of view. Such anomalies are caused by the nature of the LCD and do not indicate a malfunction.

Please note that Sony does not guarantee a replacement or refund for such cases.

Do not expose the LCD or camera lens to direct sunlight for prolonged periods of time. It may result in a malfunction. Do not store your CLIE handheld in areas subject to sunlight, such as near windows, and be careful when using outdoors.

## **Before taking pictures (CLIE Camera), recording movies (Movie Recorder) or recording sounds (Voice Recorder)**

Sony recommends taking a test picture to confirm settings, etc., before actual shooting. Take a test shot, save it, and view it to check the result. Likewise, perform tests before actual movie and sound clip recording.

## **No guarantee for lost or damaged data**

Sony does not provide any guarantee for lost or damaged data.

## **Copyrights**

Television programs, films, video tapes, and other materials may be copyrighted. Unauthorized recording of such materials may violate copyright laws.

# Setting up your CLIÉ™ handheld

This chapter explains how to charge your CLIÉ handheld and use it with your computer.

## Confirming the package contents

Please confirm that all the following accessories are included in the package before setting up your CLIÉ handheld.

### CLIÉ handheld (1)

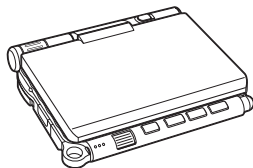

### Charger Cradle (1)

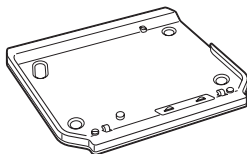

### AC power adapter (1) (including AC cord)

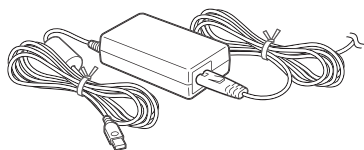

### USB cable (1)

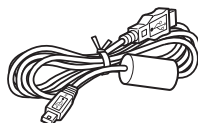

### Stylus (1)



The stylus is inserted into your CLIÉ handheld at the factory.

### Installation CD-ROM (1)

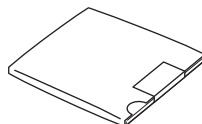

## Strap (1)

Refer to the illustration below to attach the strap.

## Read This First - Operating Instructions (1, this manual)

## Safety & Regulations Guide (1)

## Troubleshooting Q&A (1)

## Software license agreement (1)

## Other printed materials

Make sure that the package contains all of the above contents. If any item is missing, contact the Sony Customer Information Service Center or a Sony dealer.

**Use the strap to avoid dropping your CLIE handheld**

## Attaching the strap

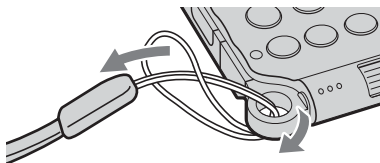

# Setting up your CLIÉ™ handheld

Perform the following before setting up your CLIÉ handheld.

Step 1: Charging your CLIÉ handheld

Step 2: Performing the initial setup after turning on your CLIÉ handheld for the first time

## Step 1: Charging your CLIÉ handheld

**Before using your CLIÉ handheld for the first time, be sure to fully charge the battery.**

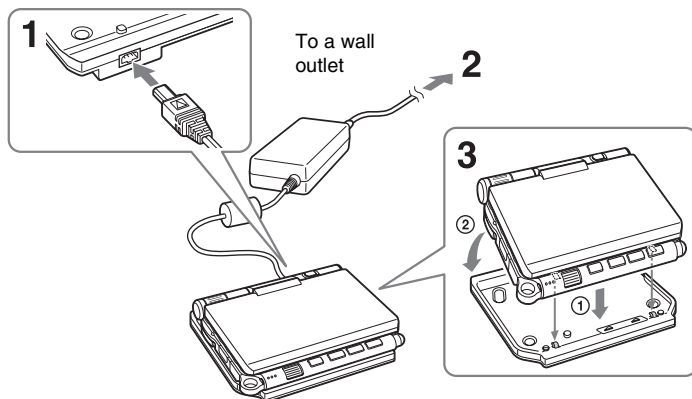

- 1** Connect the AC power adapter to the charger cradle's AC power adapter connector.
- 2** Connect the AC power adapter to a wall outlet.
- 3** Align and attach the front clasps of the charger cradle with the holes on the back of your CLIÉ handheld (①), then gently lay it down (②).

The POWER LED of your CLIÉ handheld turns on when charging starts.

### Tips

- To remove your CLIÉ handheld from the charger cradle, lift up from the rear (camera lens side).
- Clean the connectors if they get dirty.



It takes about four hours to fully charge your CLIÉ handheld for the first time. The POWER LED turns off when charging is complete.

**Tip**

Subsequent charges will require less time if you charge your CLIÉ handheld frequently.

## Step 2: Performing the initial setup after turning on your CLIÉ handheld for the first time

The first time you turn on your CLIÉ handheld, you need to make some initial settings. Follow the on-screen instructions to complete the initial setup and to become familiar with operations of your CLIÉ handheld.

### ..... Changing the operating style

You can use your CLIÉ handheld with the display panel set in three different styles.

#### ■ Carrying style

Put your CLIÉ handheld in the “carrying style” when carrying it in your bag or pocket to prevent the screen from damage.

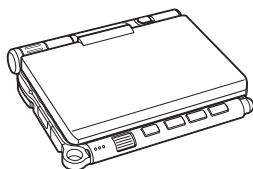

#### ■ Opened style

Put your CLIÉ handheld in the “opened style” when you enter data with the hardware keyboard.

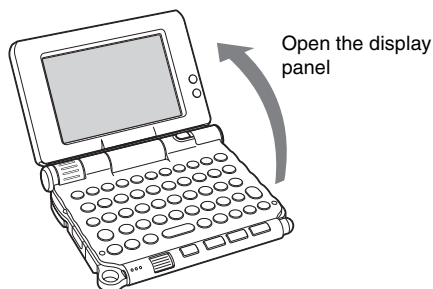

Continued on next page

## Turned style

Put your CLIE handheld in the “turned style” to make it compact when you operate it with the stylus or use it in camera mode.

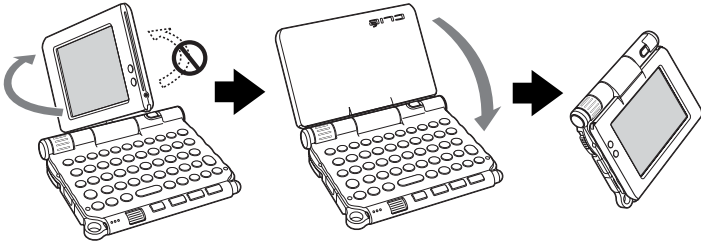

Open the display and rotate it clockwise until it clicks into place

Fold the display over the keyboard

### Note

Do not apply too much force or rotate the display panel in the wrong direction.

### Closing the display panel

Close the display panel by rotating it counterclockwise until it clicks into place.



## 1 Slide down the POWER/HOLD switch.

Your CLIÉ handheld turns on, and the **Setup** screen is displayed.

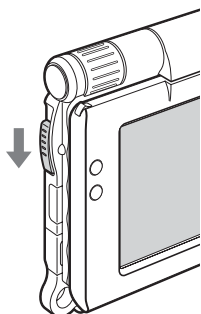

Slide down the POWER/HOLD switch

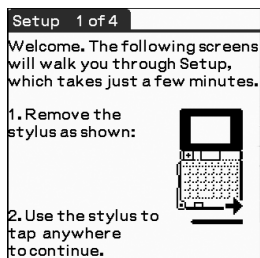

### Tips

#### If you cannot turn on your CLIÉ handheld

- Did you charge your CLIÉ handheld as described on page 8?
  - ➔ For details, refer to the supplied “Troubleshooting Q&A”.
- Perform a soft reset if you cannot turn on your CLIÉ handheld even after charging it (page 32).

## 2 Take out the stylus.

You can use the stylus to enter text or to select applications.

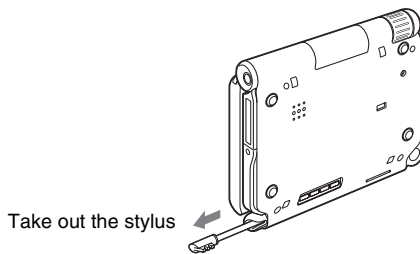

### Tip

You can extend or shorten the stylus, as shown in the illustration.

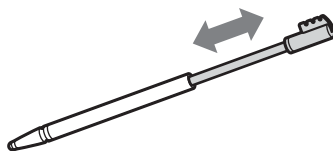

Continued on next page

### Notes

- Never use a writing pen, pencil, or other sharp object instead of the stylus to write on your CLIÉ handheld, as the screen may get scratched.
- When you put the stylus back in its holder, push it in until it clicks into place.

### 3 Press lightly on the screen with the stylus.

This action is called “tapping”.

The **Setup** screen for stylus digitizer is displayed.

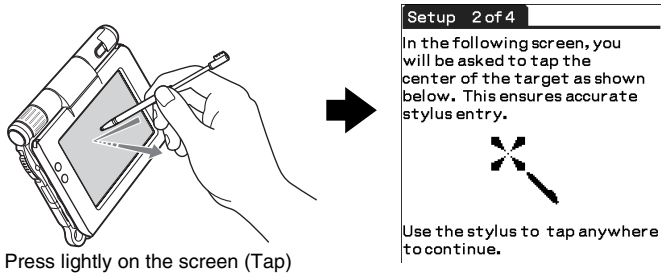

### 4 Following the on-screen instructions, tap exactly in the center of the displayed mark.

Tap the next targets, which are displayed at the bottom right and then in the center of the screen.

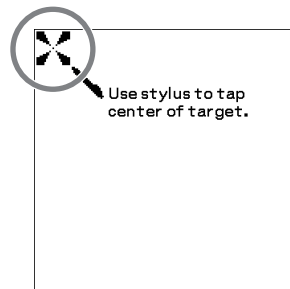

### Note

If the stylus digitizer is not configured correctly, the scroll bar may not operate properly, “tapping” may not work as expected, or other problems may occur.

- ➔ For details on reconfiguring the stylus digitizer, refer to “Customizing your CLIÉ™ handheld (Preferences): Adjusting the Digitizer” in the supplied “Handbook”.

After the stylus adjustment is complete, a screen for setting the time and date is displayed.

- 5** Tap the box next to [Set Time:].  
The **Set Time** dialog box is displayed.

**Tip**

You can reconfigure the date and time settings in the **Preferences** screen.  
 ➔ For details, refer to “Customizing your CLIE™ handheld (Preferences): Setting up the Date & Time preferences” in the supplied “Handbook”.

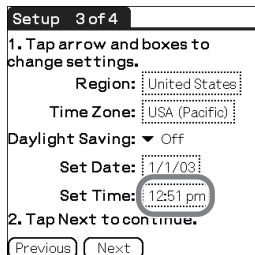

- 6** Tap ▲ or ▼ to set the current time.  
Tap each box to set the hour and minute.

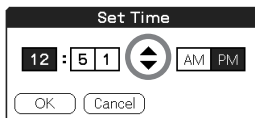

- 7** Tap [OK].  
The current time is set and the **Setup** screen is displayed.



- 8** Tap the box next to [Set Date:].  
The **Set Date** screen is displayed.

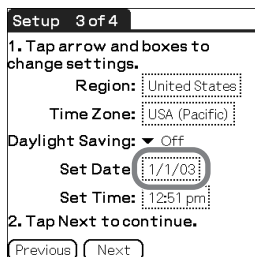

- 9** Tap ◀ or ▶ to select the current year.

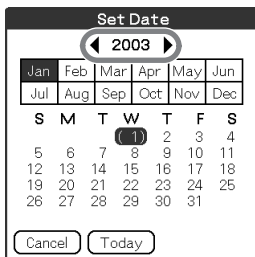

Continued on next page

**10** Tap the current month, then tap the current date.  
The **Set Date** screen closes.

**11** Tap the box next to [Time Zone:].  
The **Set Time Zone** screen is displayed.

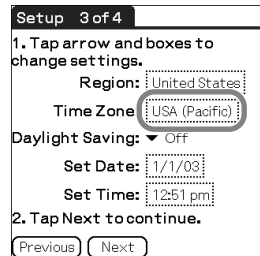

**12** Tap the region to set the time zone, then tap [OK].

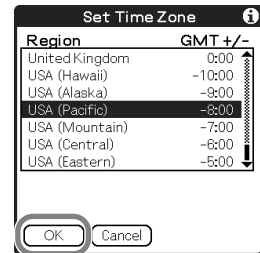

**13** Tap ▼ next to [Daylight Saving:] and select [On] or [Off].



**14** Tap [Next].

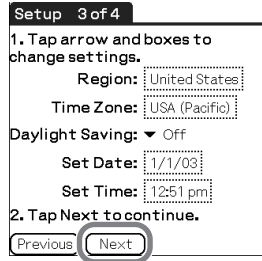

**15** Tap [Next] and [Done].

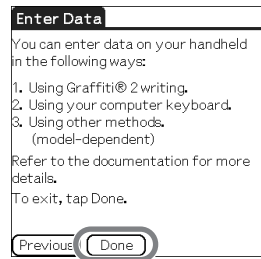
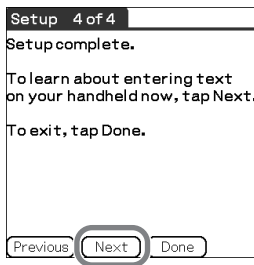

The CLIE 3D Launcher is displayed.



**The initial setup is complete.**

# Using your CLIÉ™ handheld with your computer

You can perform the following if you use your CLIÉ handheld with your computer.

- Synchronize the latest schedules and addresses between your CLIÉ handheld and your computer.
- Save a backup of your CLIÉ handheld data on your computer.
- Transfer images and music files from your computer to your CLIÉ handheld.
- Read the supplied “CLIÉ Application Manual” installed on your computer and learn how to use add-on applications in detail.

Follow the procedure below before using your CLIÉ handheld with your computer.

Step 1: Installing the software on your computer

Step 2: Connecting your CLIÉ handheld and computer via the USB cable

Step 3: Entering a user name for your CLIÉ handheld

## Step 1: Installing the software on your computer

**Do not connect your CLIÉ handheld to your computer before installing the software. Otherwise, the software may not be installed properly.**

**Palm™ Desktop for CLIÉ** stored on the supplied Installation CD-ROM must be installed on your computer. The software is used for data transfer between your CLIÉ handheld and computer, and handling data on your computer such as **Address Book**.

- For details on the system requirements of computer, refer to “System requirements” on page 97.



**Notes**

- Do not simply copy the Palm™ Desktop for CLIÉ folder from the supplied Installation CD-ROM to your computer. To install the software properly, follow the installation procedure described below.
- If you use Windows 2000 Professional or Windows XP, log on with a User Name in the Administrators group before installing the software.
- If you have more than one CLIÉ handheld and the old version of **Palm™ Desktop for CLIÉ** has already been installed on your computer, follow the installation procedure below to upgrade to the new version.
  - \* If you are using PEG-N710C Series or PEG-S300 Series, refer to your CLIÉ handheld support website. (Refer to the URL shown on the back cover of this manual.)
  - For details, refer to “Transferring data from another CLIÉ™ handheld” in the supplied “Handbook”.

**1** Quit all applications running on Windows®.

**2** Insert the supplied Installation CD-ROM into the CD-ROM drive of your computer.

The Installation Launcher window is displayed.

**3** Click [Install] for **Palm™ Desktop for CLIÉ**.

The setup program starts and the **InstallShield Wizard** window is displayed.

**Note**

If you try to install **Palm™ Desktop for CLIÉ** when another version of **Palm™ Desktop for CLIÉ** is already installed in your computer, a warning message appears on your computer window.

Uninstall the old version of **Palm™ Desktop for CLIÉ** by using [Add/Remove Programs] on [Control Panel] of your computer and install the new version.

**4** Click [Next].

The **Select Synchronization Application** window is displayed.

**5** Select the software you will use to synchronize your CLIÉ handheld with your computer.

If you select [Synchronize with Palm Desktop for CLIÉ], **Intellisync Lite** will not be installed. If you select [Synchronize with Microsoft Outlook or Lotus Organizer], both **Palm™ Desktop for CLIÉ** and **Intellisync Lite** will be installed.

**6** Click [Next].

The **Setup Type** window is displayed.

**7** Select the setup type [Complete] or [Custom] and the destination folder if you select [Custom].

**8** Click [Next].

The **Select User** window is displayed.

**9** Click [Create New User] to create a new user name in the **Select User** window.

You can enter any user name you prefer.

**Note**

**If you have more than one CLIÉ handheld**

Enter a user name that is different from the one you use for another CLIÉ handheld.

If you set an identical user name for multiple CLIÉ handhelds, errors may occur.

**Tip**

**If you want to transfer data between CLIÉ handhelds**

Refer to “Transferring data from another CLIÉ™ handheld” in the supplied “Handbook”.

**10** Click [Next].

The **Connections** window is displayed.

**11** Select [USB] or [Serial Port], depending on how you want to connect your CLIÉ handheld to your computer.

**Note**

Select [USB] for your CLIÉ handheld.

**12** Click [Next].

The **Ready to Install the Program** window is displayed.

**13** Click [Install].

**Palm™ Desktop for CLIÉ** installation starts.

Follow the on-screen instruction.

**14** Click [Finish].

**Installation of Palm™ Desktop for CLIÉ on your computer is complete.**

## Step 2: Connecting your CLIÉ handheld and computer via the USB cable

You can synchronize data between your CLIÉ handheld and computer by connecting them with the supplied USB cable after installing **Palm™ Desktop for CLIÉ**.

### About the USB cable

The supplied USB cable has two connectors. Connect the “A” plug to the USB port of your computer and the mini “B” plug to the USB connector of your CLIÉ handheld.



- 1 Connect the mini “B” plug of the USB cable to the USB connector of your CLIÉ handheld.

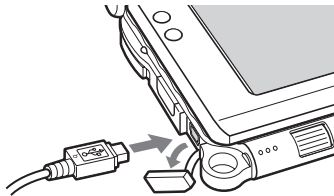

Open the USB connector cover

- 2 Connect the “A” plug of the USB cable to the USB port of your computer.

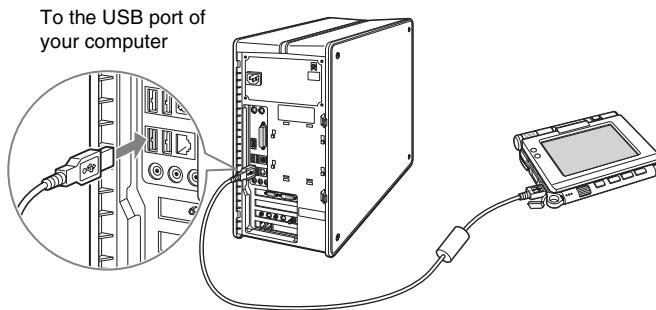

### Note

Be sure to connect the USB cable directly to a USB port of your computer. If the USB cable is connected to a computer via another device, such as a USB hub, the HotSync® operation may not work properly.

## Step 3: Entering a user name for your CLIÉ handheld

- 1 Rotate the Jog Dial™ navigator to select  (HotSync) on the CLIÉ 3D Launcher and press the Jog Dial™ navigator. The **HotSync** screen is displayed.

**Tip**

You can also tap  (HotSync) to display the **HotSync** screen.

- 2 Tap  (HotSync) in the **HotSync** screen.

The HotSync® operation starts and the installation for the required software starts automatically.

- 3 Click [OK] in the **Users** window of your computer.

A beep is heard and the HotSync® operation starts.

Your user name entered for **Palm™ Desktop for CLIÉ** is also registered in your CLIÉ handheld.

When the setup is complete, “HotSync operation complete.” will be displayed on your CLIÉ handheld.

- 4 Click [OK] on the computer window.

**The setup is complete.**

# Synchronizing data between your CLIE handheld and computer (the HotSync® operation)

## What is the HotSync® operation?

The HotSync® operation is an easy operation that allows you to synchronize data between your CLIE handheld and your computer, back up the data of your CLIE handheld to your computer, and install add-on applications.

- For details, refer to “Exchanging and updating files/data using the HotSync® operation (Other HotSync® operations)” in the supplied “Handbook”.

## Performing the HotSync® operation

The following procedure explains how to synchronize data between your CLIE handheld and computer, using **Date Book** as an example.

- 1** Turn on your computer.
- 2** Follow the procedure on page 59 and enter new schedule event in **Date Book**.
- 3** Connect your CLIE handheld and computer via the supplied USB cable.
- 4** Rotate the Jog Dial™ navigator to select  (HotSync) on the CLIE 3D Launcher and press the Jog Dial™ navigator. The **HotSync** screen is displayed.

### Tip

You can also tap  (HotSync) to display the **HotSync** screen.

**5** Tap  (HotSync) in the **HotSync** screen.

The HotSync<sup>®</sup> operation starts.

When the HotSync<sup>®</sup> operation is complete, the following screen is displayed.

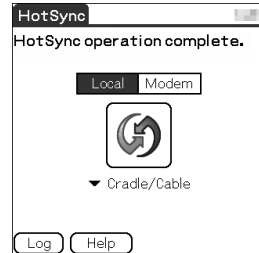

**6** Double-click  (Palm Desktop for CLIÉ) on your computer window.

**Palm™ Desktop for CLIÉ** starts and the Date Book window is displayed. If you select the same date you entered in Step 2, you will see the schedule for that day.

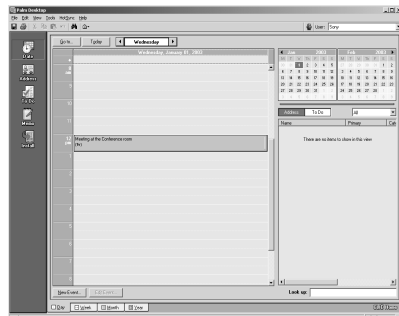

**Tip**

You can also click [Start], select [Programs] (for Windows XP, select [All Programs])-[Sony Handheld], and click [Palm Desktop for CLIÉ] to start the software.

## To display other application windows (Address Book, To Do List, and Memo Pad)

Click any icon on the left side of the window.

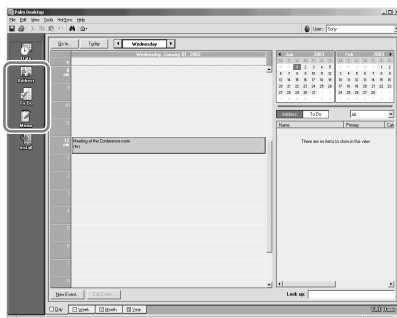

## Performing the HotSync® operation using the wireless LAN function (available for PEG-UX50 only)

You can also synchronize data between your CLIE handheld and computer using the wireless LAN function.

- For details, refer to “Exchanging and updating files/data using the HotSync® operation (Other HotSync® operations): Performing the HotSync® operation via a wireless LAN (for PEG-UX50 only)” in the supplied “Handbook”.

## Making a backup is recommended

If problems occur, even those requiring a hard reset, you can restore your CLIE handheld to the same state as it was at the last HotSync® operation.

You may not be able to back up certain add-on applications installed after the initial setup or the data created with such add-on applications.

- For backup details, refer to “Making a backup of the data or applications on your CLIE handheld” on page 85.

# Basic operations of your CLIÉ™ handheld

This chapter explains how to turn on/off your CLIÉ handheld, start an application, enter text, turn it off using Power Saving Mode and perform a reset.

## Turning on/off your CLIÉ™ handheld

### Turning on your CLIÉ handheld

Slide down the POWER/HOLD switch.

Your CLIÉ handheld turns on, and the last screen you viewed is displayed.

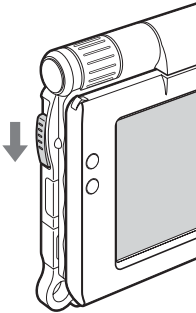

Slide down the POWER/HOLD switch

#### Tip

**If you cannot turn on your CLIÉ handheld**

Did you fully charge your CLIÉ handheld?

➔ For details, refer to the supplied “Troubleshooting Q&A”.



## Turning off your CLIE handheld

Slide down the POWER/HOLD switch again.

### Tip

If you do not use your CLIE handheld for long periods of time, you can save the battery power using Power Saving Mode.

- ➔ For details on Power Saving Mode, refer to “Turning off your CLIE™ handheld using Power Saving Mode” on page 30.

## Starting an application

To work with your CLIE handheld, you need to start an application.

The following explains how to start an application.

- ➊ Displaying the CLIE 3D Launcher
- ➋ Selecting an application
- ➌ Quitting the application

The following shows how to start applications from the CLIE 3D Launcher using the Jog Dial™ navigator.

## Using the Jog Dial™ navigator and the BACK button

### ➊ Displaying the CLIE 3D Launcher

- ➊ Tap  (Home).

The CLIE 3D Launcher is displayed.



## 2 Selecting an application

- 1 Rotate the Jog Dial™ navigator to select an application to start.  
An application is selected.

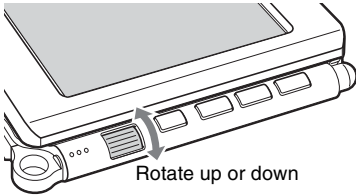

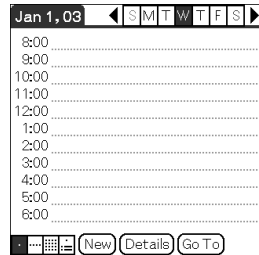
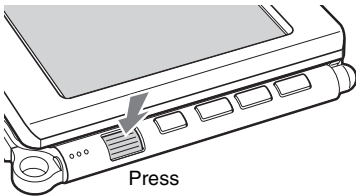

- 2 Press the Jog Dial™ navigator.  
The selected application starts.



### Tip

#### To select an application easily

If you press the BACK button while the CLIE 3D Launcher is displayed,  (Pointer) moves to the scroll bar on the right. You can then scroll to the row of the application icons by rotating the Jog Dial™ navigator. Press the Jog Dial™ navigator again to move  (Pointer) back to the desired application icon.

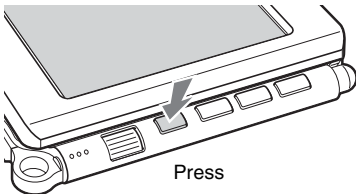

### ③ Quitting the application

You do not need to save data manually on your CLIE handheld as you do on a computer, although some applications require data be saved.

► For details, refer to the “CLIE Application Manual” installed on your computer. To switch from one application to another, you need to display the CLIE 3D Launcher again. You can use either of the following methods to display the CLIE 3D Launcher.

► **Return to the CLIE 3D Launcher by tapping  (Home).**

► **Return to the CLIE 3D Launcher by pressing and holding the BACK button.**

#### Tip



You can also switch from one application to another by pressing the Application buttons (page 28).

## Other ways to start an application

You can also start an application using the stylus or application buttons.

### Using the stylus

Start the application by pressing the screen directly with the supplied stylus.

1 Tap   on the CLIE 3D Launcher to display the application you want to start.

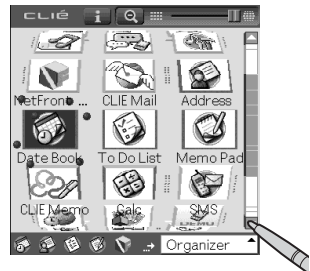

Continued on next page



- 2** Tap the application icon.  
The selected application starts.



## Pressing the application buttons

You can also start the applications by pressing the application buttons.

The default setting of the application buttons are:

 **NetFront**,  **CLIE Mail**,  **Date Book** for PEG-UX50

 **Date Book**,  **Address Book**,  **Memo pad** for PEG-UX40

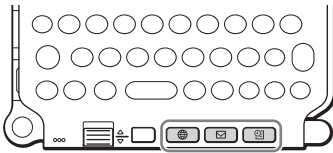

for PEG-UX50

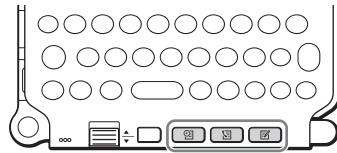

for PEG-UX40

### Tips

- Even when your CLIÉ handheld is off, you can start an application by pressing one of the application buttons.
- You can assign your favorite applications to the application buttons.
  - ➔ For details, refer to “Customizing your CLIÉ™ handheld (Preferences): Assigning applications to application buttons” in the supplied “Handbook”.

## About Internal Media

Your CLIÉ handheld is built with a storage area of memory, called “Internal Media”. Internal Media is an extended storage area which is different from the main storage area of your CLIÉ handheld and data stored on Internal Media will not be deleted even if the battery power is gone.

- ➔ For details on Internal Media, refer to “Using storage media such as “Memory Stick™” media” in the supplied “Handbook”.

# Entering text

There are five ways to enter text into your CLIÉ handheld. You can use whichever is the most comfortable for you.

## ● **Hardware keyboard (page 103)**

You can enter text using the hardware keyboard in the same way as your computer's keyboard. This is useful when you want to enter lots of text.

## ● **Handwriting system**

There are two ways of using the handwriting system.

➔ For details, refer to "Entering text on your CLIÉ™ handheld" in the supplied "Handbook".

## **Graffiti® 2**

You can enter text using a stroke recognition program, **Graffiti® 2**.

## **Decuma Input**

You can enter text using **Decuma Input**, which converts your handwriting into typed text as you write.

## ● **On-screen keyboard**

You can enter text by tapping the on-screen keyboard.

➔ For details, refer to "Entering text on your CLIÉ™ handheld: Using the on-screen keyboard to enter text" in the supplied "Handbook".

## ● **The HotSync® operation with a computer**

You can enter text using your computer keyboard and then performing the HotSync® operation. The text data is transferred from your computer to your CLIÉ handheld with **Palm™ Desktop for CLIÉ**.

➔ For details, refer to [Help] in **Palm™ Desktop for CLIÉ**.

# Turning off your CLIÉ™ handheld using Power Saving Mode

To use your CLIÉ handheld over an extended period of time, you can save the battery power of your CLIÉ handheld by using Power Saving Mode when turning off your CLIÉ handheld. Normally, the battery power is consumed to preserve saved data within your CLIÉ handheld. This occurs even when your CLIÉ handheld is turned off. However, in Power Saving Mode, data is stored on a storage area that requires no power, thus prolonging battery life.

## Notes

- Turning on/off your CLIÉ handheld in Power Saving Mode requires a bit more time than usual.
- Never press the RESET button while Power Saving Mode is saving or restoring data.
- You cannot use the alarm feature if you turn off your CLIÉ handheld in Power Saving Mode.
- The data that is previously backed up will be overwritten when you turn off your CLIÉ handheld in Power Saving Mode.

## Turning off your CLIÉ handheld (Power Saving Mode)

- 1 Select  (Prefs) in the CLIE 3D Launcher to start **Preferences**.

The **Preferences** screen is displayed.

- 2 Tap  at the top right of the screen and select [Power Saving].

The Power Saving screen is displayed.

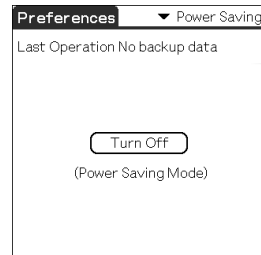

- 3 Tap [Turn Off].  
The **Turn off** dialog box is displayed.
- 4 Tap [Yes].  
The data of your CLIÉ handheld is saved in Power Saving Mode.  
The data will be automatically restored next time you turn on your CLIÉ handheld.

### To erase the saved data

- 1 Tap ▼ at the top right of the **Preferences** screen and select [Power Saving].  
The Power Saving screen is displayed.
- 2 Tap  (Menu).  
The menu is displayed.
- 3 Select [Erase backup] from [Option].

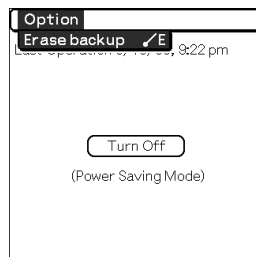

The **Erase Backup** dialog box is displayed.

- 4 Tap [OK].

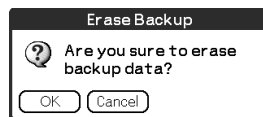

The saved data is erased.

# Restarting your CLIÉ™ handheld

Normally, you do not need to reset your CLIÉ handheld. However, if your CLIÉ handheld does not turn on or respond, performing a soft reset may solve the problem.

To reset your CLIÉ handheld, follow the procedure below.

.....

## Performing a soft reset

All records and add-on applications stored on your CLIÉ handheld are retained even after performing a soft reset.

Gently press the RESET button with the stylus.

The system shuts down and your CLIÉ handheld restarts.

After restarting, it displays “palm POWERED”, “SONY” and “CLIÉ”, followed by the **Preferences** screen for setting up the time and date.

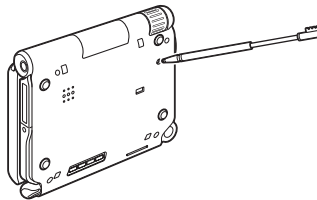

### Notes

- After the RESET button is pressed, it takes a while before the **Preferences** screen is displayed. Do not press the RESET button again while resetting.
- Do not press the RESET button with anything other than the stylus, as a malfunction may occur.



## Performing a hard reset

If the soft reset does not solve the problem, you will need to perform a hard reset to restart your CLIÉ handheld.

### Notes

- **All records and add-on applications stored on your CLIÉ handheld will be erased by performing a hard reset.** (All records and add-on applications stored on Internal Media will be retained.)
- Perform a hard reset only if a soft reset does not solve the problem. However, you can restore your CLIÉ handheld data if it was saved in Power Saving Mode (page 30). You can also restore the data if you have made a backup on your computer via the HotSync® operation.

- 1 Slide down and hold the POWER/HOLD switch.
- 2 Press the RESET button gently with the stylus, and then release the stylus.

### Note

Keep the POWER/HOLD switch held down.

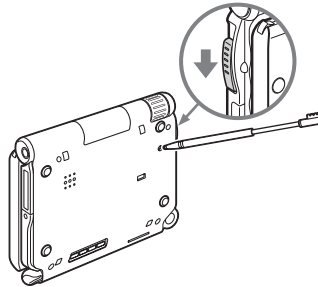

- 3 Wait for more than three seconds after the **palm POWERED** screen is displayed, and release the POWER/HOLD switch. A message “Erase all data?” is displayed.

**4** Press  (Page Up) on the hardware keyboard.

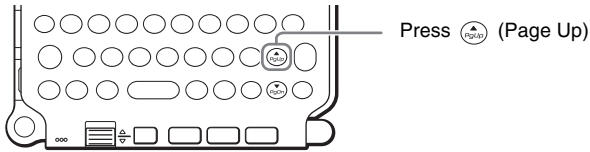

**Tip**

If you want to cancel the hard reset, press any key other than  (Page Up).

The **Backup data** dialog box is displayed.

**5** Tap [No] after verifying the message on the dialog box.



The hard reset is performed.

(All records and add-on applications stored on Internal Media will be retained.)

**Tip**

When you tap [Yes], the last data you saved will be restored on your CLIÉ handheld.

After restarting, your CLIÉ handheld displays “palm POWERED”, “SONY” and “CLIÉ”, followed by the **SETUP** screen. Refer to “Step 2: Performing the initial setup after turning on your CLIÉ handheld for the first time” on page 9 for the initial setup.

After a hard reset, only the current date and time are retained. Formats, Preferences, and other controls revert to the factory settings.

**Notes**

- After the RESET button is pressed, it takes a while before the **Setup** screen is displayed. Do not press the RESET button again while resetting.
- If  (Page Up) is not pressed long enough, the hard reset may not be performed.

# Connecting to the Internet

This chapter explains how to connect to the Internet using the wireless LAN function.

## Notes

- **The wireless LAN function is available for PEG-UX50 only.**
- You can also access the Internet using the Bluetooth® function.
  - ➔ For details on using the Bluetooth® function, refer to “Using the Bluetooth® function: Connecting to the Internet by communicating with a Bluetooth® compatible mobile phone” in the supplied “Handbook”.

Your CLIÉ handheld is built with a wireless LAN function that complies with IEEE802.11b. You can access the Internet via a wireless LAN access point using the wireless LAN function.

## Note

To connect to the Internet via a wireless LAN access point, you may need to be a subscriber to a telecommunications company and an Internet Service Provider (ISP) in advance.

## Preparing for the wireless LAN function

You need to perform the following preparations before connecting to the Internet using the wireless LAN function.

Follow the procedure explained on the specified pages to use the wireless LAN function.

### **Step 1: Verifying the settings for the wireless LAN access point (Page 36)**

To connect to the Internet using the wireless LAN function, verify the settings for the wireless LAN access point.



### **Step 2: Preparing the check sheet (Page 37)**

Prepare the check sheet to record the settings provided by your System Administrator and Internet Service Provider (ISP). For more information you need, ask your System Administrator or Internet Service Provider.



### **Step 3: Setting up the wireless LAN function (Page 38)**

You need to set up the wireless LAN function of your CLIÉ handheld, referring to the check sheet with the settings.

## **Step 1: Verifying the settings for the wireless LAN access point**

To connect to the Internet using the wireless LAN function of your CLIÉ handheld, you need the settings below for the wireless LAN access point.

- SSID (also called ESSID or Network Name.)
- WEP key (also called Encryption.)

You may need a user ID or password if you configure a wireless LAN access point.

➔ For details, ask the System Administrator of your wireless LAN network.

#### **Tip**

WEP key is a security function that encrypts transferred data.

#### **Note**

Your CLIÉ handheld uses the channels 1-11 (2.4GHz band of frequencies).

## Step 2: Preparing the check sheet

You can enter the settings for connecting to the Internet using the wireless LAN function in this check sheet. The settings you enter will be needed in “Step 3: Setting up the wireless LAN function” (Page 38), “Setting up NetFront v3.0 for CLIE” (Page 40), and “Setting up CLIE Mail” (Page 43).

### Tip

When you use DHCP, you do not need the settings for ③ Primary DNS, ④ Secondary DNS, ⑤ IP address, ⑥ Netmask (Subnet mask), and ⑦ Router (Gateway).

### Check Sheet



Requirement setting	Your setting
① SSID	
② WEP Key	
③ Primary DNS	. . .
④ Secondary DNS	. . .
⑤ IP Address	. . .
⑥ Netmask (Subnet mask)	. . .
⑦ Router (Gateway)	. . .
<b>When using proxy server</b>	
⑧ Address (or Host name) and port number for proxy server	
⑨ E-mail address	@
⑩ Incoming mail server (POP3)	
⑪ Outgoing mail server (SMTP)	
⑫ Mail account name/User name	
⑬ Mail account password/User password (POP account password)	

### Note

Ask the System Administrator of your wireless LAN network for settings to connect to the wireless LAN access point, and ask your Internet Service Provider (ISP) for settings to connect to the Internet.

## Step 3: Setting up the wireless LAN function

You need to set up the wireless LAN function, referring to the settings you recorded on the check sheet.

- 1 Tap  (Prefs) in the CLIE 3D Launcher to start **Preferences**, then tap  at the top right of the screen and [Network].  
The Network screen is displayed.
- 2 Tap [ Service:], then tap [Wireless LAN] and [Details...].

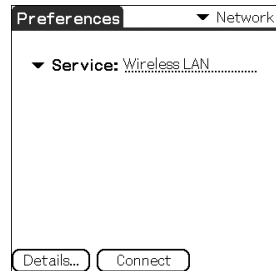

The **Wireless LAN Setup** screen is displayed.

- 3 Tap  (Menu).  
The menu is displayed.
- 4 Tap [New...] from [SSID].  
The **SSID Setup** screen is displayed.
- 5 Enter the settings for the wireless LAN access point, referring to the check sheet.

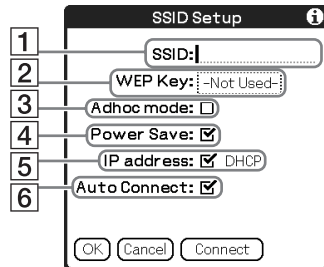

**1 SSID**

Enter the setting for **1** SSID recorded on the check sheet.

**Note**

Alphabet input is case sensitive.

**2 WEP Key**

Enter the setting for **2** WEP Key recorded on the check sheet.

**3 Adhoc mode**

You can communicate with other wireless LAN compatible devices (e.g. wireless LAN enabled PC) without connecting to the wireless LAN access point when [Adhoc mode:] is selected.

**4 Power Save**

You can enable the power saving function when [Power Save:] is selected.

**Note**

You cannot select [Power Save:], when [Adhoc mode:] is selected.

**Tip**

You can disable the power saving for communicating with maximum power when the wireless LAN is unstable. However, the battery power is quickly consumed. Select [Power Save:] for normal use.

**5 IP address**

Deselect [IP address:] to disable DHCP, and you can enter the settings for **3** Primary DNS, **4** Secondary DNS, **5** IP Address, **6** Netmask (Subnet mask), and **7** Router (Gateway) in the following **IP Address** screen.

**6 Auto Connect**

When [Auto Connect:] is selected, the wireless LAN access point can be a candidate to be automatically connected by your CLIÉ handheld when it accesses wireless LAN.

**6** Tap [OK].

The **Wireless LAN Setup** screen is displayed.

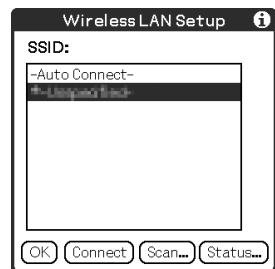
**7** Tap [OK].

The **Preferences** screen is displayed.

# Browsing websites

You can access the Internet via the wireless LAN access point using **NetFront v3.0 for CLIE**.

## Setting up NetFront v3.0 for CLIE

- 1 Select  (NetFront 3.0) in the CLIE 3D Launcher to start **NetFront v3.0 for CLIE**.

The browser screen is displayed.

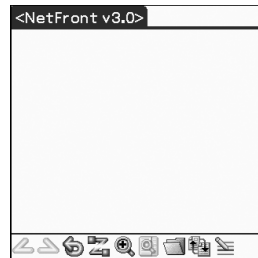

- 2 Tap  (Menu) and [NetFront Settings] from [Options].

The first page of the **NetFront Settings** screen is displayed.

- 3 Tap  at the bottom right of the screen to display the second page of the **NetFront Settings** screen.

The **NetFront Settings** screen for [Connections] is displayed.



## 4 Set up the connection method.

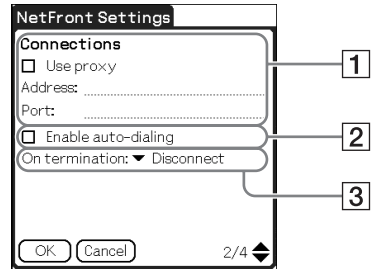

### 1 Use proxy

This setting is not needed for normal use.

If your Internet Service Provider (ISP) provides you with proxy server address, select [Use proxy] and enter address (or host name) and port number for proxy server.

### 2 Enable auto-dialing

You can access the Internet automatically without displaying the **Prompt** dialog box when [Enable auto-dialing] is selected.

### 3 On termination

You can select how **NetFront v3.0 for CLIE** closes.

[Never Disconnect]: keeps your connection to the Internet open for use with other applications.

[Disconnect]: disconnects from the Internet when **NetFront** closes or another application is started.

[Prompt]: displays the **Prompt** dialog box, whether you want to disconnect or stay connected.

## 5 Tap [OK].

The browser screen is displayed.

## 6 Tap (Menu) and [Preferences] from [Options].

The Network screen of **Preferences** is displayed.

## 7 Verify that [Wireless LAN] is selected next to [ ▼ Service:].

### Tip

If [Wireless LAN] is not selected, tap [ ▼ Service:] to select it.

## 8 Tap [Done].

The browser screen is displayed.

Setting up NetFront v3.0 for CLIE is complete.

# Browsing websites by connecting to the Internet via the wireless LAN access point

**1** Select  (NetFront 3.0) in the CLIE 3D Launcher to start **NetFront v3.0 for CLIE**.

The browser screen is displayed.

**2** Tap  (Off line) .

The **Prompt** dialog box is displayed.

**Tip**

When [Enable auto-dialing] is selected in the second page of the **NetFront Settings** screen, the connection automatically starts.

**3** Tap [OK].

When your CLIE handheld is connected to the Internet,  (On line) is displayed.

**Tips**

- The Wireless LAN LED of your CLIE handheld lights.
- You can check the reception level for the wireless LAN on the status bar (Page 109).

.....

## Viewing a website

**1** On the browser screen, tap  (Menu) and [Enter Address] from [Open].

The **Enter Address** screen is displayed.

**2** Enter the URL for the website you want to view.

**Tip**

You can use shortcut entries by tapping [▼ Assistant].

**3** Tap [OK].

The website you entered is displayed.

.....

## Disconnecting the connection

Tap  (On line) in the browser screen to disconnect the connection.

 (Off line) is displayed when your CLIE handheld is disconnected from the Internet.

➔ For details on the Internet connection, refer to “Internet/E-mail” in the “CLIE Application Manual” installed on your computer.

## Sending/Receiving e-mail messages

You can send/receive e-mail messages using **CLIE Mail**.

### Setting up CLIE Mail

- 1 Select  (CLIE Mail) in the CLIE 3D Launcher to start **CLIE Mail**. The **CLIE Mail** screen is displayed.

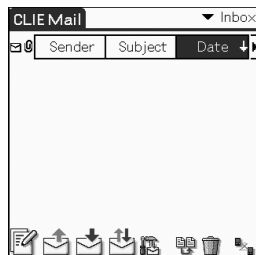

- 2 Tap  (Menu) and [Accounts] from [Options]. The **Accounts** screen is displayed.
- 3 Tap [New]. The **New Account** screen for [Name] is displayed.
- 4 Enter your display name when you send e-mail messages and tap [Next]. The **New Account** screen for [E-mail address] is displayed.

**5** Enter **9** E-mail address recorded on the check sheet, then tap [Next].

The **New Account** screen for [E-mail Server Names] is displayed.

**6** Enter **10** Incoming mail server (POP3) and **11** Outgoing mail server (SMTP) recorded on the check sheet, then tap [Next].

The **New Account** screen for [Internet Mail Logon] is displayed.

**7** Enter **12** Mail account name/User name and **13** Mail account password/User password, and tap [Next].

The **New Account** screen for [Congratulations] is displayed.

**8** Tap [Finish].

The **Accounts** screen is displayed.

**9** Tap [OK].

The **CLIE Mail** screen is displayed.

**10** Tap  (Menu) and [Networks] from [Options].

The Network screen of **Preferences** is displayed.

**11** Verify that [Wireless LAN] is selected next to [ ▼ Service:].

**Tip**

If [Wireless LAN] is not selected, tap [ ▼ Service:] to select it.



**12** Tap [Done].

The **CLIE Mail** screen is displayed.

**Setting up CLIE Mail is complete.**

# Sending e-mail messages

You can send e-mail messages with **CLIE Mail**.

- 1** Select  (CLIE Mail) in the CLIE 3D Launcher to start **CLIE Mail**.  
The **CLIE Mail** screen is displayed.
- 2** Tap  (New).  
The **Edit** screen is displayed.
- 3** Enter the e-mail address of receiver, a subject, and text.

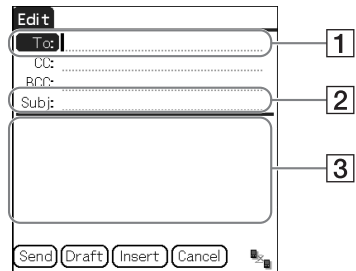



- 1 To**  
Enter the mail address of the receiver.
- 2 Subject**  
Enter a subject for the e-mail.
- 3 Enter the e-mail text.**

- 4** Tap [Send] and [Send Now].  
After connecting to the Internet, the **Communication Status** screen is displayed and the e-mail is sent.



### Tip

When you tap [Send Later], the e-mail is temporarily saved in [Outbox].  
The saved e-mail will be sent when you tap  (Send).

- 5** Tap [OK].  
The **CLIE Mail** screen is displayed.
- 6** Tap  (On line).  
 (Off line) is displayed when disconnected.

# Receiving e-mail messages

You can receive e-mail messages with **CLIE Mail**.

- 1** Tap  (Receive) in the **CLIE Mail** screen.  
After connecting to the Internet, the **Communication Status** screen is displayed and you can receive e-mail messages.
  - 2** Tap [OK].  
The received mail is displayed in [Inbox] in the **CLIE Mail** screen.
  - 3** Tap  (On line).  
 (Off line) is displayed when disconnected.
  - 4** Tap the received mail.  
The text of the received mail is displayed.
- For details on setup, sending or receiving e-mail messages, refer to “Internet/E-mail” in the “CLIE Application Manual” installed on your computer.

# Have a try

## Enjoying image files

You can take pictures and view image files using your CLIÉ handheld as a digital still camera.

- **Application to be used:**

- Taking pictures: **CLIE Camera**
- Viewing image files: **CLIE Viewer**

➔ For details, refer to “Still images” in the “CLIÉ Application Manual” installed on your computer.

Have a try

---

## Taking pictures

**1** Press the CAPTURE/REC button to start **CLIE Camera**.

**Tip**

You can also tap  (CLIE Camera) in the CLIE 3D Launcher to start **CLIE Camera**.

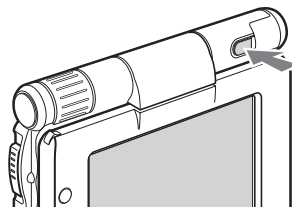

Continued on next page

- 2** Point the built-in camera directly at the subject by rotating the camera lens.

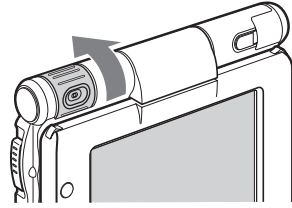

- 3** Position the subject in the viewfinder and press the CAPTURE/REC button.  
A picture is taken.

**Tip**

You can also tap  (CAPTURE) on the CLIE Camera screen to take a picture.

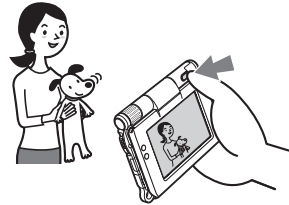

.....

## Viewing image files

You can view image files using **CLIE Viewer**.

- ➔ For details, refer to “Viewing handwritten memos and image files, and playing back voice memos” on page 55.

**Tip**

You can also tap  (CLIE Viewer) on the CLIE Camera screen to start **CLIE Viewer**.



# Enjoying image files

## Getting Ready



### Taking pictures

CLIE Camera..... page 74

### Importing image files from your computer

Image Converter..... page 76



## Viewing/Selecting



### Viewing/Selecting image files by searching from the list

CLIE Viewer ..... page 74



## Utilizing features



### Organizing image files in albums

CLIE Album..... page 75

### Exporting image files to your computer

PictureGear Studio ..... page 76



### Displaying image files one after the other

PhotoStand ..... page 75



### Editing image files

Photo Editor..... page 76



### Attaching image files to addresses

Address Book..... page 81



### Sending image files with e-mail messages

CLIE Mail ..... page 80



### Transferring image files to your computer

Data Import ..... page 84

# Enjoying movies

You can record movies using your CLIÉ handheld as you do with digital video camera.

Movie files are saved on a “Memory Stick” media or Internal Media.

- **Applications to be used:**

- Recording movies: **Movie Recorder**
- Viewing movies: **Movie Player** or **CLIE Viewer**

➔ For details, refer to “Movies” in the “CLIÉ Application Manual” installed on your computer.

---

## Recording movies

- 1 Select  (Movie Rec) in the CLIE 3D Launcher to start **Movie Recorder**.



- 2 Point the built-in camera directly at the subject by rotating the camera lens.

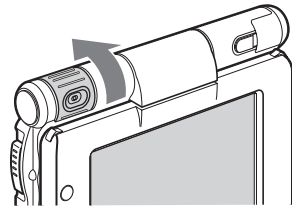

- 3 Position the subject in the viewfinder and press the **CAPTURE/REC** button.  
Movie recording starts.

**Tip**

You can also tap  (REC) on the Movie Recorder screen to record.

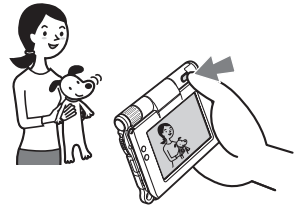

- 4 Press the **CAPTURE/REC** button again to stop recording.

.....  
**Viewing movies**

You can view movies using **CLIE Viewer** or **Movie Player**.

- ➔ For details, refer to “Viewing handwritten memos and image files, and playing back voice memos” on page 55.

.....

# Enjoying movies

## Getting Ready



### Recording movies

Movie Recorder ..... page 77

### Importing movie files from your computer

Image Converter ..... page 76

Giga Pocket Plugin ..... page 78



## Viewing/Selecting



### Viewing/Selecting movies by searching from a list

CLIE Viewer ..... page 74



### Playing back movies

Movie Player ..... page 77



## Sending



### Sending movies with e-mail messages

CLIE Mail ..... page 80

# Recording a voice memo (Voice Recorder)

You can record sounds using the built-in microphone of your CLIE handheld. You can also use the voice memo as an alarm sound or attach it to an e-mail.

• **Applications to be used:**

- Recording a voice memo: **Voice Recorder**
- Playing back a voice memo: **Voice Recorder** or **CLIE Viewer**

➔ For details, refer to “Voice Recorder” in the “CLIE Application Manual” installed on your computer.

## Recording a voice memo

- 1 Select  (Voice Rec) in the CLIE 3D Launcher to start Voice Recorder.

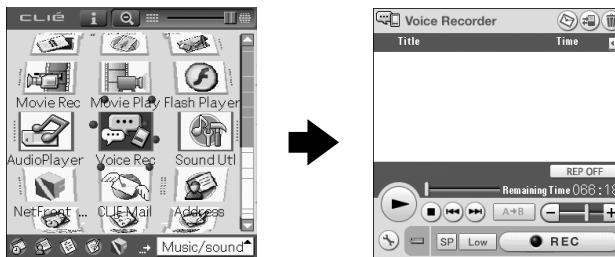

- 2 Press the CAPTURE/REC button.  
Voice memo recording starts.  
Speak directly into the built-in microphone.

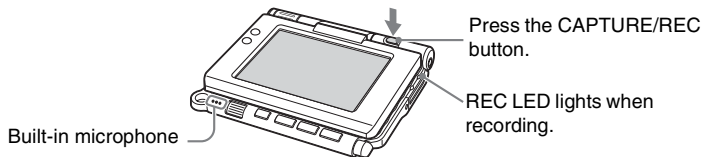

### Tips

- You can also tap  in the **Voice Recorder** screen to start recording.
- There are two modes of recording for voice memo, **High** (to record at meetings or in a quiet and/or spacious place) and **Low** (to record dictation or in a noisy place).
- ➔ For details, refer to “Voice Recorder” in the “CLIE Application Manual” installed on your computer.

Have a try

Continued on next page

**3** Press the CAPTURE/REC button again to stop recording.

**Tip**

You can also tap  or  in the **Voice Recorder** screen to stop recording.

.....

## Playing back a voice memo

You can play back a voice memo using **Voice Recorder** or **CLIE Viewer**.

- ➔ For details on **Voice Recorder**, refer to “Voice Recorder” in the “CLIE Application Manual” installed on your computer.
- ➔ For details on **CLIE Viewer**, refer to “Viewing handwritten memos and image files, and playing back voice memos” on page 55.

# Viewing handwritten memos and image files, and playing back voice memos

You can use **CLIE Viewer** to view handwritten memos, image files, and movie files, and to play back the voice memos saved on your CLIE handheld, Internal Media, or “Memory Stick” media. These different types of files are arranged by date so you can easily find the file you want to open.

You can also attach image files or movie files to your e-mail messages, or select data to use with applications, such as **PhotoStand**, **CLIE Album**, or **Photo Editor**.

## Note

The destination where data/files are saved varies, depending on the data/files you use.

➔ For details, refer to the “CLIE Application Manual” installed on your computer.

- **Application to be used:** CLIE Viewer

- **Data to be used:**

- Image files: JPEG (DCF) format, PictureGear Pocket format
- Movie files: Movie Player format, MPEG Movie format
- Handwritten memos
- Voice memos

➔ For details on file formats you can play back or view with your CLIE handheld, refer to “CLIE Viewer” in the “CLIE Application Manual” installed on your computer.

Have a try

## Opening/Playing back files

1 Select  (CLIE Viewer) in the CLIE 3D Launcher to start **CLIE Viewer**.

The file list screen is displayed.

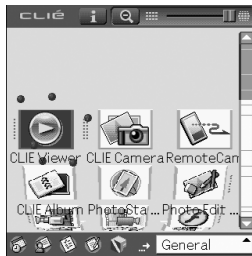

## Tip

You can also tap  (CLIE Viewer) on the CLIE Camera screen to start **CLIE Viewer**.

Continued on next page

- 2 Rotate the Jog Dial™ navigator to select the file you want to display and press the Jog Dial™ navigator.  
The selected file is displayed or played back.

**Tips**

- You can also tap the file to display or play it back.
- The files are displayed by date of creation.

.....

## Selecting/Deleting files

You can select an image or movie file from the list screen in **CLIE Viewer** (including files on your CLIE handheld, Internal Media, or “Memory Stick” media) to attach to your e-mail messages, use the image files in other applications, or delete files.

**Note**

The destination where data/files are saved varies, depending on the data/files you use.  
➤ For details, refer to the “CLIE Application Manual” installed on your computer.

- 1 Start **CLIE Viewer**.

- 2 Tap a command button to select a function.

- ☐ : The selected file will be attached to an e-mail
- 🖨 : The selected image file will be added to **PhotoStand**
- 🗑 : The selected file will be deleted
- ▼ : Choose other applications, **Photo Editor** or **CLIE Album** by using the pull-down menu



- 3 Tap  (Check Box) to select the file.

**Tip**

Tap [Select all] to select all the files.

- 4 Tap [OK].

The function selected in step 2 is performed.

**Tip**

The instructions in Step 3 and 4 may be inappropriate and differ from the actual operations depending on applications.  
➤ For details, refer to the “CLIE Application Manual” installed on your computer.



# Listening to music

You can listen to music on your CLIÉ handheld by transferring music files from your computer to the Internal Media of your CLIÉ handheld or to a “Memory Stick” media inserted into your CLIÉ handheld.

- **Applications to be used:**

- Transferring music files in ATRAC3 format: **Audio Player** and **SonicStage** (for PC)
- Transferring music files in MP3 format: **Data Import** and **Data Export** (for PC)
- Playing back music files on your CLIÉ handheld: **Audio Player**

- **Required media:** “MagicGate Memory Stick” media (ATRAC3 format only)

- **Formats to be used:** ATRAC3 and MP3 formats

- **Setup:**

- ① Prepare your CLIÉ handheld to use with your computer.
  - ➔ For details, refer to “Using your CLIÉ™ handheld with your computer” on page 16.

- ② Install **SonicStage** and **Data Export** on your computer.

➔ For details, refer to “Music” in the “CLIÉ Application Manual” installed on your computer.

Have a try

## ..... Transferring music files to your CLIÉ handheld

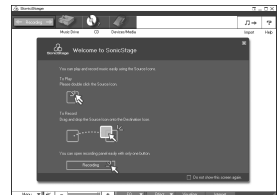

You can transfer music files from your computer to your CLIÉ handheld using **SonicStage** or **Data Export**.



## ..... Playing back music data

- 1 Select  (Audio Player) in the CLIE 3D Launcher to start Audio Player.



- 2 Tap  (Playback) to play music.  
Tap  (Stop) to stop the music.



Playback      Stop

### Tip

You can use separately sold headphones.  
(Your CLIE handheld accepts stereo mini-jack headphones.)

# Managing schedule events (Date Book)

You can save important dates and times, such as for conferences or business trips.

- **Application to be used: Date Book**

► For details, refer to “Date Book” in the “CLIÉ Application Manual” installed on your computer.

## Entering a schedule event

**1** Press the  button on your CLIÉ handheld to start **Date Book**.

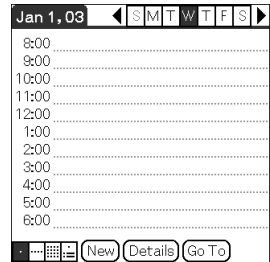

**2** Tap [New] and set the start time and end time of the schedule event.

- 1 Tap to set the start time.
- 2 Tap to set the end time.
- 3 Tap to select “hour”.
- 4 Tap to select “minute”.
- 5 Tap to confirm the settings.

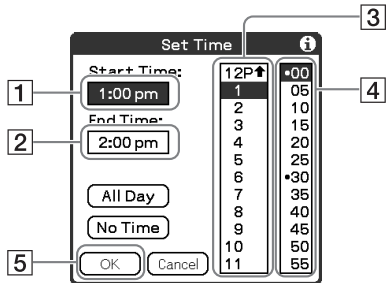

Have a try

Continued on next page

### 3 Enter a schedule event.

**Tip**

- ➔ For details on entering text, refer to “Entering text on your CLIÉ™ handheld” in the supplied “Handbook”.



## Deleting a schedule event

- 1 Tap a schedule event you want to delete and tap  (Menu).  
The menu is displayed.

- 2 Tap [Delete Event...] from [Record].



The **Delete Event** dialog box is displayed.

- 3 Tap [OK].

**Tip**

The deleted data from your CLIÉ handheld will be saved on your computer the next time you perform the HotSync® operation if you have selected [Save archive copy on PC] on the **Delete Event** screen.

To view the saved data on your computer, open **Palm™ Desktop for CLIÉ**, and select [Open Archive...] from [File] in the Date Book window.

# Managing addresses and telephone numbers (Address Book)

You can register information such as names, addresses and telephone numbers, and attach an image.

You can also attach an image file or create a business card from your own address information and send it to another CLIE handheld or Palm OS® compatible device via beaming.

- **Application to be used: Address Book**

► For details, refer to “Address Book” in the “CLIE Application Manual” installed on your computer.

## ..... Entering a new address

- 1 Select  (Address) in the CLIE 3D Launcher to start **Address Book**.
- 2 Tap [New].

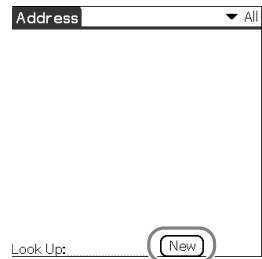

The **Address Edit** screen is displayed.

- 3 Tap each item to enter details.

**Tip**

You can scroll the screen by tapping ▲/▼ at the bottom right.



# .....

## Deleting an address entry

- 1 Tap the address record you want to delete and tap  (Menu).  
The menu is displayed.
- 2 Tap [Delete Address...] from [Record].

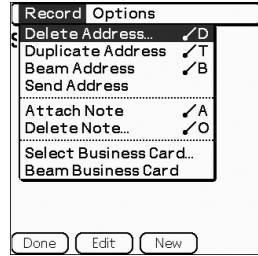

The **Delete Address** screen is displayed.

- 3 Tap [OK].

### Tip

The deleted data from your CLIÉ handheld will be saved on your computer the next time you perform the HotSync® operation if you have selected [Save archive copy on PC] on the **Delete Address** screen.

To view the saved data on your computer, open **Palm™ Desktop for CLIÉ**, and select [Open Archive...] from [File] in the Address Book screen.

# Exchanging Date Book and Address Book data between your CLIÉ handheld and computer

The HotSync<sup>®</sup> operation (page 21) enables you to exchange Date Book and Address Book data between your CLIÉ handheld and computer.

Depending on the software on your computer, there are two ways to exchange data.

## Exchanging data between your CLIÉ handheld and Palm™ Desktop for CLIÉ on your computer

You can synchronize data between **Date Book** or **Address Book** managed by **Palm™ Desktop for CLIÉ** on your computer, and your CLIÉ handheld.

- **Setup:** Install **Palm™ Desktop for CLIÉ** on your computer.

➔ For details on how to synchronize data with **Palm™ Desktop for CLIÉ**, refer to “Synchronizing data between your CLIÉ handheld and computer (the HotSync<sup>®</sup> operation)” on page 21.

## Exchanging data between your CLIÉ handheld and Microsoft® Outlook (Intellisync® Lite) on your computer

- **Setup:** Install **Intellisync Lite** on your computer.

➔ For details on how to install, refer to the “CLIÉ Application Manual” installed on your operation.

### Tip

**Intellisync Lite** can be installed if you select [Synchronize with Microsoft Outlook or Lotus Organizer] when you install **Palm™ Desktop for CLIÉ**.

➔ For details on how to start and set up, refer to [Help] in **Intellisync Lite**.

To view the help menu, click [Start], select [Programs] (for Windows XP, select [All Programs])- [Intellisync Lite], and click [Intellisync Help].

# Viewing computer documents on your CLIÉ handheld (Picstel Viewer for CLIE)

You can view documents created in Microsoft® Word/Excel/PowerPoint® or PDF files on your CLIÉ handheld.

- **Applications to be used:** Picstel Viewer for CLIE, Data Import and Data Export (for PC)
  - **Formats to be used:** doc, xls, ppt, txt, JPEG, GIF, PNG, BMP, PDF, and HTML formats
  - **Setup:**
    - ① Prepare your CLIÉ handheld to use with your computer.
      - ➔ For details, refer to “Using your CLIÉ™ handheld with your computer” on page 16.
    - ② Install **Data Export** on your computer.
      - ➔ For installation details, refer to the “CLIÉ Application Manual” installed on your computer.
- ➔ For details, refer to “Picstel Viewer for CLIE” in the “CLIÉ Application Manual” installed on your computer.

.....

## Transferring the documents to your CLIÉ handheld

- 1** Prepare the documents on your computer that you want to view on your CLIÉ handheld.
- 2** Connect your CLIÉ handheld to your computer (page 19).
- 3** Insert a “Memory Stick” media into your CLIÉ handheld.
  - ➔ For details on “Memory Stick” media, refer to “Using “Memory Stick” media” on page 102.

**Tip**

Documents can also be transferred to Internal Media of your CLIÉ handheld.



- Transfer the documents to the “Memory Stick” media inserted into your CLIE handheld. Use **Data Import** and **Data Export** to transfer documents to the “Memory Stick” media.

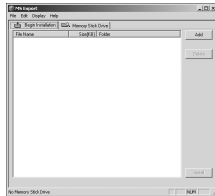

Data Export  
(for PC)

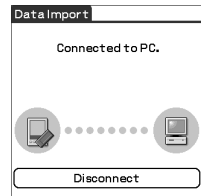

Data Import  
(for CLIE handheld)

## Viewing the documents

- Select  (PicselViewer) in the CLIE 3D Launcher to start **Picsel Viewer for CLIE**.

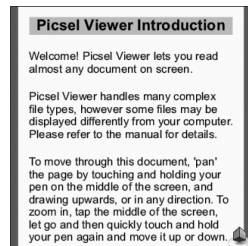
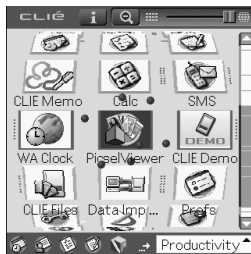

- Tap  at the bottom right of the screen. The Carousel menu screen is displayed.

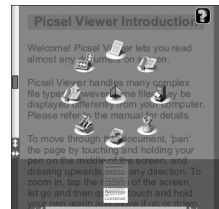

- Tap , then tap the document you want to view from the “Memory Stick” media. The document is displayed.

### Tip

Documents stored in Internal Media can also be viewed with **Picsel Viewer for CLIE**.

# Using the Bluetooth<sup>®</sup> function

The Bluetooth<sup>®</sup> function is a new technology that enables wireless communication for mobile phones, computers and other mobile devices.

The Bluetooth<sup>®</sup> function enables wireless communication within a range of approximately 33 feet (approximately 10 meters)<sup>1)</sup>. You can use the function to exchange data, such as image files, between your CLIÉ handheld and other Bluetooth<sup>®</sup> compliant devices.

## What you can do with the Bluetooth<sup>®</sup> function

- **Exchanging data such as image files or Date Book data with another CLIÉ handheld<sup>2)</sup>**

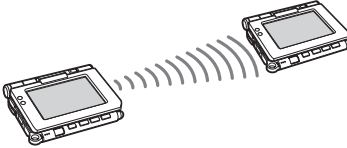

- **Synchronizing your CLIÉ handheld with a computer wirelessly<sup>2)</sup>**



- **Remotely operating a digital still camera<sup>2)</sup> or camcorder<sup>2)</sup> from your CLIÉ handheld**



- **Connecting to the Internet via a mobile phone<sup>2)</sup>**



- 1) The actual range will vary depending on factors such as obstacles between devices, magnetic fields around a microwave oven, static electricity, interference, radio wave conditions, reception sensitivity or antenna performance, the operating system, or software application, etc.
- 2) The other device must be compliant with the Bluetooth® function.
  - ➔ For information on compliant devices, refer to the URL shown on the back cover of this manual.

- **Setup:** Set the Bluetooth® function to be enabled.

## Enabling/Disabling the Bluetooth® function



Select  (Prefs) in the CLIE 3D Launcher

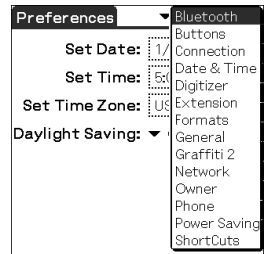

Tap ▼ at the top right of the screen and select [Bluetooth]

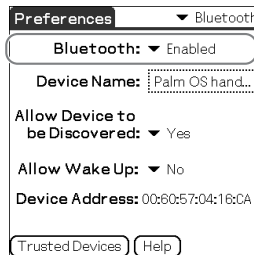

Select [Enabled] or [Disabled]

Have a try

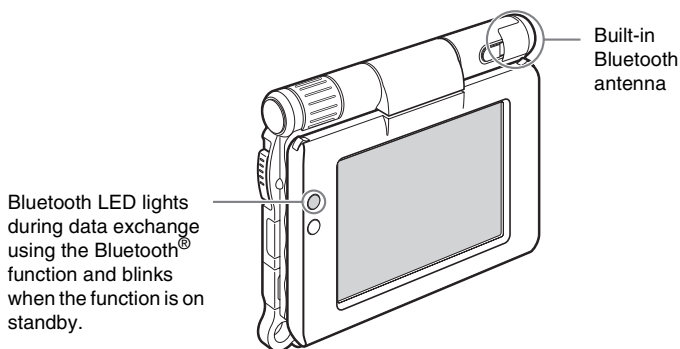

➔ For details, refer to “Customizing your CLIÉ™ handheld (Preferences): Setting the Bluetooth® function” in the supplied “Handbook”.

### Notes

- Communication performance decreases if the antenna touches a metal object.
- Avoid covering the antenna with your hand while using the Bluetooth® function, otherwise radio reception may be interrupted.
- You cannot use the Bluetooth® function and the wireless LAN function simultaneously (the wireless LAN function is available for PEG-UX50 only).

When you change the setting of the Bluetooth® function or try to use the Bluetooth® function while your CLIÉ handheld is connected to the wireless LAN, the **Bluetooth** dialog box is displayed, to confirm that you want to have your CLIÉ handheld disconnected from the wireless LAN. Tap [Yes] if you want to disconnect from the wireless LAN or [No] if you do not want to (if you tap [No], you cannot use the Bluetooth® function).

- Sending files using the Bluetooth® function may result in failure if you continuously send many files one after another or a very large file, depending on reception conditions.

# Exchanging data such as image files or Date Book data with another CLIE handheld

## Note

Depending on where you live, this function may not be available.

- 1 Select a file or data you want to send.

## ■ Sending an image file, movie file, voice memo or handwritten memo

Start **CLIE Viewer** (page 55), tap  (Menu) to display the menu, select [Send...] from [Data], and tap the file you want to send.

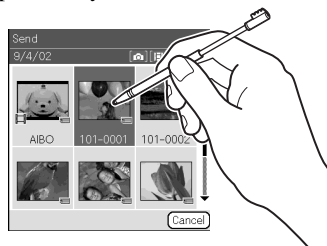

Have a try

## Tip

### Sending image files

You can select a method for sending data from the **Send With** dialog box. (The dialog box below may not be displayed depending on your operating environment)

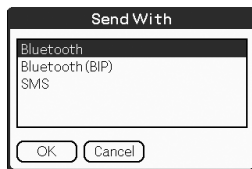

### Example

**Bluetooth (BIP):** This is to send file in an optimized format for the target devices.

Continued on next page

**Note**

**Remote Camera** is not available in some areas.

➔ For details, refer to “CLIÉ Application Manual” installed on your computer.

**Sending Date Book or Address Book data**

Tap the schedule or address data you want to send, tap  (Menu) to display the menu, and then select [Send Event] (for **Date Book**) or [Send Address] (for **Address Book**) from [Record].

**2 Send the file or data.**

After the **Bluetooth Discovery** dialog box is displayed, the list of Bluetooth® compatible CLIÉ handhelds within the range of the communication area is displayed on the **Discovery Results** dialog box. Tap to select the CLIÉ handheld to which you want to send data.

The **Bluetooth Progress** dialog box will be displayed on both CLIÉ handhelds. Follow the on-screen instructions.

**Tip**

If you rename a target Bluetooth® compatible device after your CLIÉ handheld has already detected it, the device may be listed under the previous name the next time it is detected.

In this case, follow the procedure below.

- ① Open the setup screen for the Bluetooth® (page 67) and tap  (Menu).
- ② Tap [Disable device name cache] from [Options].
- ③ Detect the target Bluetooth® compatible device again.

**Note**

To view or edit received files/data, applications supporting each file/data need to be installed on your CLIÉ handheld.

.....  
**Synchronizing your CLIÉ handheld with a computer wirelessly**

If you are using a Bluetooth® compatible computer, you can wirelessly synchronize files or data, between your CLIÉ handheld and computer without connecting the supplied USB cable to the computer.

- ➔ For details, refer to “Exchanging and updating files/data using the HotSync® operation (Other HotSync® operations): Performing the HotSync® operation using the Bluetooth® function” in the supplied “Handbook”.
- ➔ For information on the compliant devices, refer to the URL shown on the back cover of this manual.

## Remotely operating a digital still camera or camcorder from your CLIÉ handheld

### Note

Depending on where you live, this function or compatible devices may not be available.

You can remotely control and capture images on a Bluetooth® BIP compatible digital still camera (Sony DSC-FX77)\* and camcorder (Sony DCR-TRV80 or DCR-TRV80E)\* using your CLIÉ handheld.

➔ For details, refer to “Remote Camera” in the “CLIÉ Application Manual” installed on your computer.

\* Not available in some areas.

## Connecting to the Internet via a mobile phone

You can browse websites or exchange e-mail messages via a Bluetooth® compatible mobile phone.

- **Application to be used:**

- To browse websites: **NetFront v3.0 for CLIE**
- To exchange e-mail messages: **CLIE Mail**

- **Required device:** Bluetooth® compatible mobile phone

- **Setup:** Establish internet access through an internet service provider in advance. To use the network, you need to configure the network properties, set up an internet connection and register your mobile phone.

➔ For details, refer to “Using the Bluetooth® function: Connecting to the Internet by communicating with a Bluetooth® compatible mobile phone” in the supplied “Handbook”.

# Using applications

This section introduces applications and the “CLIÉ Application Manual”. For details on how to use applications, refer to the “CLIÉ Application Manual” for each application.

## Types of applications

There are three types of applications:

- **Applications already installed on your CLIÉ handheld**
- **Applications you need to install on your CLIÉ handheld**
- **Applications you need to install on your computer**

## Using the CLIÉ Application Manual

You can read the “CLIÉ Application Manual” installed on your computer for details on how to use applications.

### Notes



- Prior to using applications, refer to “Step 1: Installing the software on your computer” on page 16 to install **Palm™ Desktop for CLIÉ**. The “CLIÉ Application Manual” will be installed at the same time.
- You need **Microsoft Internet Explorer Version 5.0** or later to display the “CLIÉ Application Manual” properly.



# Opening the CLIÉ Application Manual

- 1 Double-click  (CLIÉ info) on your computer window. The **SONY CLIÉ handheld information** window is displayed.
- 2 Click [Manuals] and then [CLIÉ Application Manual]. The **CLIÉ Application Manual** window is displayed.

## Tips

- To close the **CLIÉ Application Manual** window, click  at the top right of the window.
- You can minimize the **CLIÉ Application Manual** window by clicking  at the top right of the window. You can reopen the minimized window by clicking the CLIÉ Application Manual button in the task bar.
- You can operate other software while the **CLIÉ Application Manual** window is displayed on the Windows desktop.
- You can also open the “CLIÉ Application Manual” directly from the Installation CD-ROM.
  - 1 Insert the Installation CD-ROM into the CD-ROM drive of your computer.
  - 2 Click [Manuals].
  - 3 Click [View] at the right of [View Manuals].

# Introducing applications

In this section, the applications are introduced in order of the CLIE 3D Launcher groups.

- For details on the CLIE 3D Launcher groups, refer to “CLIE™ handheld basic operations: Using CLIE 3D Launcher” in the supplied “Handbook”.

## General

### ▶ Viewing/Playing back a file after selecting from the list

- Application to be used

**CLIE Viewer** CLIE handheld

- Summary

For managing and displaying image files, movie files, handwritten memos and voice memo files.

- For details, refer to the “CLIE Application Manual” installed on your computer.



## Picture

### ▶ Taking pictures

- Application to be used

**CLIE Camera** CLIE Handheld

- Key

JPEG (DCF) format

- Summary

For taking pictures using the built-in camera of your CLIE handheld.

- For details, refer to the “CLIE Application Manual” installed on your computer.





## Remotely operating a digital still camera or camcorder from your CLIÉ handheld

### Note

Depending on where you live, this function may not be available.

### Application to be used

**Remote Camera** CLIÉ handheld

### Summary

You can remotely control and capture images on a **Bluetooth BIP** compatible digital still camera (Sony DSC-FX77)\* and camcorder (Sony DCR-TRV80 or DCR-TRV80E)\* using your CLIÉ handheld.

➔ For details, refer to the “CLIÉ Application Manual” installed on your computer.

\* Not available in some areas.



## Organizing image files in albums

### Application to be used

**CLIE Album** CLIÉ handheld

### Summary

For managing image files saved on your CLIÉ handheld, Internal Media or “Memory Stick” media, in an album format.

You can use the albums with your computer using **PictureGear Studio** installed on your computer.

➔ For details, refer to the “CLIÉ Application Manual” installed on your computer.



## Creating and playing a slide show

### Application to be used

**PhotoStand** CLIÉ handheld

### Key

JPEG (DCF) format

### Summary

For automatically displaying your image files in sequence.

➔ For details, refer to the “CLIÉ Application Manual” installed on your computer.





## Editing image files

- Application to be used  
**Photo Editor** CLIÉ handheld

- Key  
JPEG (DCF) format

- Summary

For drawing or writing on an image file. You can also draw pictures on a new blank canvas.

➔ For details, refer to the “CLIÉ Application Manual” installed on your computer.



## Importing image/movie files from your computer

- Application to be used  
**Image Converter** PC

- Key  
JPEG (DCF) format, Movie Player format

- Summary

For converting image and movie files on your computer to a format that is viewable on your CLIÉ handheld.

- Preparation for use: **Must be installed**

- Installation CD-ROM Menu  
“CLIÉ Image”

➔ For details, refer to the “CLIÉ Application Manual” installed on your computer.

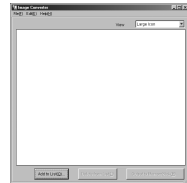

## Exporting albums and binders to your computer

- Application to be used  
**PictureGear Studio** PC

- Summary

What you can do with **PictureGear Studio**:

- Create albums and binders on your computer and import binders to your CLIÉ handheld.
- Export images to your computer and manage them.
- Print out labels for CD-ROM, “Memory Stick” media and more.

- Preparation for use: **Must be installed**

- Installation CD-ROM Menu  
“CLIÉ Image”

➔ For details, refer to the “CLIÉ Application Manual” installed on your computer.



## Movie



### Recording movies

- **Application to be used**

**Movie Recorder** CLIÉ handheld

- **Key**

Movie Player format (movie formats shot with your CLIÉ handheld or converted using **Image Converter** or **Giga Pocket Plugin**)

- **Summary**

For recording movies using the built-in camera of your CLIÉ handheld.

➔ For details, refer to the “CLIÉ Application Manual” installed on your computer.



[www.aibo.com](http://www.aibo.com)



### Playing back movies

- **Application to be used**

**Movie Player** CLIÉ handheld

- **Key**

Movie Player format (movie formats shot with CLIÉ handheld or converted using **Image Converter** or **Giga Pocket Plugin**),  
MPEG Movie format (MPEG1 format movie files shot with a Sony Digital Still Camera or Handycam),  
Play List, Repeat function, and Index function.

- **Summary**

For playing back movies recorded with the built-in camera of your CLIÉ handheld or playing back movies on your CLIÉ handheld using **Image Converter** or **Giga Pocket Plugin** on your computer.

➔ For details, refer to the “CLIÉ Application Manual” installed on your computer.



[www.aibo.com](http://www.aibo.com)

Have a try

## **Playing back Macromedia® Flash™ files**

- **Application to be used**  
**Macromedia Flash Player 5**

**CLIÉ handheld**

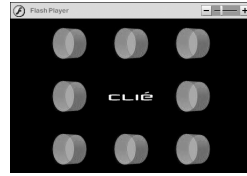

- **Key**  
swf format

- **Summary**  
For playing back the Macromedia Flash files.  
Some Flash files that are created for computers may not play back properly on your CLIÉ handheld.

➔ For details, refer to the “CLIÉ Application Manual” installed on your computer.

## **Importing movie files from your computer**

### **Note**

Only supported areas

- **Application to be used**  
**Giga Pocket Plugin** **PC**

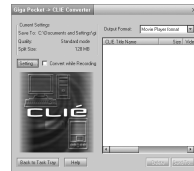

➔ For details, refer to “CLIÉ Application Manual” installed on your computer.

- **Key**  
Movie Player format

- **Summary**  
For converting movie files on your computer to a format that is viewable on your CLIÉ handheld.  
You need to install **Giga Pocket Version 2.0** or later for VAIO on your computer.

- **Preparation for use:** **Must be installed**

- **Installation CD-ROM Menu**  
“CLIÉ Image”

➔ For details, refer to [Help] in **Giga Pocket Plugin** installed on your computer.

## Music/Sound



### Listening to music with your CLIÉ handheld

- Application to be used

**Audio Player** CLIÉ handheld

- Key

MP3 format, ATRAC3 format

- Summary

For playing back music files saved on a “Memory Stick” media or Internal Media.

- Preparation for use: Needs to be connected to your computer

Requires a “MagicGate Memory Stick” media (ATRAC3 format only)\*

\*To play back ATRAC3 format music files, you need “MagicGate Memory Stick” media. To play back MP3 format music files, you can use “MagicGate Memory Stick” media or “Memory Stick” media, or transfer the files into Internal Media of your CLIÉ handheld.

➔ For details, refer to the “CLIÉ Application Manual” installed on your computer.



### Recording voice memo

- Application to be used

**Voice Recorder** CLIÉ handheld

- Summary

For recording and playing back a voice memo using the built-in microphone of your CLIÉ handheld.

➔ For details, refer to the “CLIÉ Application Manual” installed on your computer.



### Managing the alarm sound

- Application to be used

**Sound Utility** CLIÉ handheld

- Summary

For managing alarm sounds converted with **Voice Recorder**.

➔ For details, refer to the “CLIÉ Application Manual” installed on your computer.

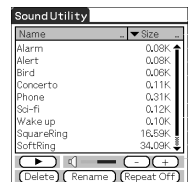

# Transferring music files to your CLIÉ handheld



Application to be used  
**SonicStage** PC

Key  
ATRAC3 format

Summary  
For managing and creating music files on your computer, to be played back with your CLIÉ handheld.

The application is also used for transferring music files to a “Memory Stick” media.

Preparation for use: **Must be installed**

Installation CD-ROM Menu  
“CLIÉ Audio”

For details, refer to the “CLIÉ Application Manual” and [Help] in **SonicStage** installed on your computer.

## Internet

### Browsing websites

Application to be used  
**NetFront v3.0 for CLIÉ** CLIÉ handheld

Key  
Websites, Internet, WWW browser

Summary  
For browsing websites with your CLIÉ handheld.

Preparation for use: **Must be connected to the Internet**

For details, refer to the “CLIÉ Application Manual” installed on your computer.

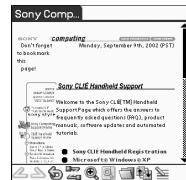

### Sending and receiving e-mail messages

Application to be used  
**CLIE Mail** CLIÉ handheld

Summary  
For sending and receiving e-mail messages on your CLIÉ handheld.

Preparation for use: **Must be connected to the Internet**

For details, refer to the “CLIÉ Application Manual” installed on your computer.

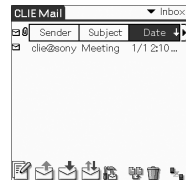



## Organizer



### Managing addresses and telephone numbers

- Application to be used  
**Address Book** **CLIÉ handheld**

- Summary**

For entering and editing information such as names, addresses or telephone numbers.

➔ For details, refer to the “CLIÉ Application Manual” installed on your computer.

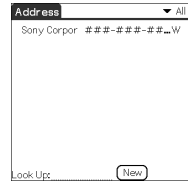

### Managing schedule events

- Application to be used  
**Date Book** **CLIÉ handheld**

- Summary**

For managing scheduled events such as conferences or business trips.

➔ For details, refer to the “CLIÉ Application Manual” installed on your computer.

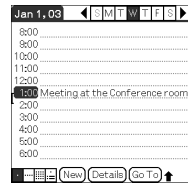

### Managing tasks and things to do

- Application to be used  
**To Do List** **CLIÉ handheld**

- Summary**

For displaying tasks that you want to be reminded of later. You can assign a priority to any task.

➔ For details, refer to the “CLIÉ Application Manual” installed on your computer.

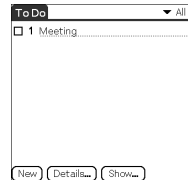

### Taking memos

- Application to be used  
**Memo Pad** **CLIÉ handheld**

- Summary**

For taking text format memos.

➔ For details, refer to the “CLIÉ Application Manual” installed on your computer.

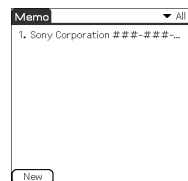



## Taking handwritten memos using the stylus

- Application to be used  
**CLIE Memo** CLIE handheld

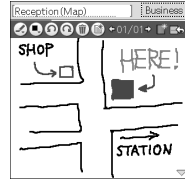

### Summary

For taking handwritten memos using the stylus.

- For details, refer to the “CLIE Application Manual” installed on your computer.



## Using the calculator

- Application to be used  
**Calculator** CLIE handheld

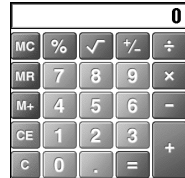

### Summary

For calculating with your CLIE handheld. You can save and recall calculations with the calculator’s memory.

- For details, refer to the “CLIE Application Manual” installed on your computer.

## Telephone



## Sending/Receiving messages and data via a connected GSM mobile phone device

- Application to be used  
**SMS** CLIE handheld



### Summary

For sending/receiving messages from your CLIE handheld via a connected GSM device, such as a mobile phone.

- For details, refer to the “CLIE Application Manual” installed on your computer.

## Productivity

### **Displaying the worldwide local time**

■ **Application to be used**  
**World Alarm Clock** CLIE handheld

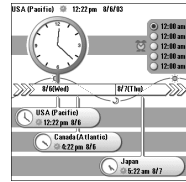

■ **Summary**

For displaying worldwide local times. You can also use the application as an alarm clock.

➔ For details, refer to the “CLIE Application Manual” installed on your computer.

### **Viewing computer documents on your CLIE handheld**

■ **Application to be used**  
**Picisel Viewer for CLIE** CLIE handheld

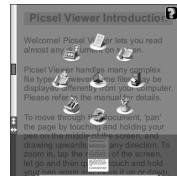

■ **Key**

doc format, xls format, ppt format, txt format, JPEG format, GIF format, PNG format, BMP format, PDF format, HTML format

■ **Summary**

For viewing documents created in Microsoft® Word/Excel/PowerPoint® or PDF files on your CLIE handheld.

➔ For details, refer to the “CLIE Application Manual” installed on your computer.

## Data Control

### **Exchanging data between your CLIE handheld and storage media**

■ **Application to be used**  
**CLIE Files** CLIE handheld



■ **Summary**

For exchanging data (copy, move, delete) between your CLIE handheld and storage media such as a “Memory Stick” media inserted into your CLIE handheld or Internal Media, or for exchange data between the storage media.

➔ For details, refer to the “CLIE Application Manual” installed on your computer.

Have a try



## Accessing “Memory Stick” media or Internal Media in your CLIÉ handheld from your computer

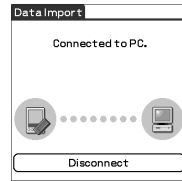

■ **Application to be used**

**Data Import** CLIÉ handheld

**Data Export** PC

■ **Summary**

For installing applications or copying data from your computer to a “Memory Stick” media or Internal Media in your CLIÉ handheld, without using the HotSync® operation.

■ **Preparation for use:** **Data Export must be installed**

■ **Installation CD-ROM Menu**

“CLIÉ Utilities”

➔ For details, refer to the “CLIÉ Application Manual” installed on your computer.

## Synchronizing data with Microsoft® Outlook or Lotus Organizer



■ **Application to be used**

**Intellisync Lite** PC

■ **Summary**

For synchronizing data of **Date Book**, **Address Book**, **To Do List**, etc., on your CLIÉ handheld with **Microsoft Outlook** or **Lotus Organizer** on your computer.

■ **Preparation for use:** **Must be installed**

**Needs to be connected to your computer**

■ **Installation CD-ROM Menu**

Select [Synchronize with Microsoft Outlook or Lotus Organizer] when installing **Palm™ Desktop for CLIÉ**, and follow the on-screen instructions.

➔ For details, refer to the “CLIÉ Application Manual” and [Help] in **Intellisync Lite** installed on your computer.

## Additional information

This section describes how to solve common problems you may have when using your CLIÉ handheld.

### Making a backup of the data or applications on your CLIÉ handheld

Sony recommends that you make a backup of your data in case of unexpected problems. Backing up your data will ensure that it can be restored again on your CLIÉ handheld, even if you have to perform a hard reset.

#### Making a backup using the HotSync® operation

Data or applications on your CLIÉ handheld is backed up to your computer when the HotSync® operation is performed. If you need to perform a hard reset, this would erase all user data or applications stored on your CLIÉ handheld. However, the erased data or applications can be restored with the next HotSync® operation.

(All user data or applications stored on Internal Media will be retained.)

#### Notes

- Some add-on applications (and data thereof) installed on your CLIÉ handheld may not be backed up. Especially, add-on applications installed via infra-red beaming or via “Memory Stick” media cannot be backed up using the HotSync® operation.
- When you need to restore data, and so on, make sure that you perform the HotSync® operation immediately after you perform a hard reset. Otherwise, if you create new data on your CLIÉ handheld between the hard reset and performing the HotSync® operation, the data may be lost.

# Resetting your CLIÉ handheld to the factory setting

When you want to reset your CLIÉ handheld to the factory setting, perform the following to delete all data and applications stored on your CLIÉ handheld.

- 1** Perform a hard reset to delete all data or applications stored on your CLIÉ handheld.
  - ➔ For details on hard reset, refer to “Restarting your CLIÉ™ handheld: Performing a hard reset” on page 33.
- 2** Delete the data or applications saved in Power Saving Mode.
  - ➔ For details on Power Saving Mode, refer to “Turning off your CLIÉ™ handheld using Power Saving Mode: To erase the saved data” on page 31.
- 3** Delete the data or applications stored on Internal Media using **CLIE Files**.
  - ➔ For details on **CLIE Files**, refer to “Using storage media such as “Memory Stick™” media: Starting CLIE Files” in the supplied “Handbook”.

# Troubleshooting

If you have problems, please follow the procedure below.  
Make note of any messages or alerts that are displayed.

## Step 1: Refer to “Troubleshooting Q&A” or the manuals for the specific application

- Read the supplied “Troubleshooting Q&A” carefully.
- Double-click  (CLIÉ Info) on your computer window, and select [Manuals] to read the details about the specific application.

## Step 2: Refer to the Sony CLIÉ handheld Support website

Double-click  (CLIÉ Info) on your computer window, and select [CLIÉ™ Handheld Support].

### Note

Thousands of third party add-on applications are available for the Palm OS® platform. Sony does not support third party applications. If you have a problem with a third party application, contact the developer or publisher of that application.

# Customer Support and Customer Registration

## ■ For customer support information

Double-click  (CLIÉ Info) on your computer window, and select [CLIÉ™ Handheld Support].

## ■ For online customer registration (For customers in the U.S.A. and Canada only)

Double-click  (CLIÉ Info) on your computer window, and select [Sony CLIÉ™ Registration].



# Notes on use

## ..... Handling your CLIÉ handheld

- Make sure you do not scratch or damage your CLIÉ handheld's screen. Always use the supplied stylus to tap on the screen. Do not use a writing pen, pencil, or other sharp object on the screen.
- Do not expose your CLIÉ handheld to rain or moisture. Should water enter the circuitry through the buttons and switches, your CLIÉ handheld may be damaged.
- Your CLIÉ handheld's screen is made of glass. Do not drop or submit your CLIÉ handheld to excessive shock. Do not carry your CLIÉ handheld in your pocket. If you sit down with your CLIÉ handheld in the pocket, your CLIÉ handheld may break.
- Avoid using or storing your CLIÉ handheld in locations subject to:
  - extremely high temperatures, such as inside a car exposed to the sun, or near a heater.
  - direct sunlight
  - high humidity
  - excessive dust
- The rubber feet of the charger cradle may lose their adhesion if they become dirty. If this occurs, clean the rubber feet with a soft damp cloth.

### Cleaning your CLIÉ handheld

- Clean your CLIÉ handheld with a soft, dry cloth.
- Wipe any dirt and dust from the camera lens by using a soft damp cotton swab.

### If condensation occurs

Turn off your CLIÉ handheld for approximately one hour to clear condensation before use. If you leave condensation within the camera lens, you may not be able to take clear pictures.

### Cleaning the stylus

Tapping or dragging the screen with a dirty stylus may damage the screen surface.

Wipe the stylus with a dry cloth when it gets dirty.

.....

## Battery considerations

### Battery safety

To avoid possible damage from battery leakage, observe the following:

- Do not use any other type of battery in your CLIÉ handheld.
- Do not charge the battery in any other way than as specified in this manual.
- Do not throw the battery into fire.
- Do not attempt to short-circuit the battery.
- Do not take the battery apart.
- Do not modify the battery.
- Do not heat the battery in an oven.
- Do not charge the battery near an open flame or in direct sunlight.
- Do not leave the battery in a car.
- Do not subject your CLIÉ handheld or the battery to excessive shock.
- Take care not to drop your CLIÉ handheld, give pressure to it with a sharp object, or crush with a heavy object.
- If you have skin contact with battery leakage or get some in your eye, wash with water immediately and consult a doctor.

### Charging

- It takes approximately four hours to charge your CLIÉ handheld when the battery is empty.
- If you charge your CLIÉ handheld every day, it takes only a few minutes to charge the battery.
- You can operate your CLIÉ handheld while the battery is being charged.

### Battery life

Battery life varies depending on the conditions and environment where you use your CLIÉ handheld and applications used.

- ➔ For details about battery life, refer to “Specifications” on page 93.

## Conserving the battery

- Turn off the backlight under good lighting conditions.
  - ➔ For details on the backlight, refer to “POWER/HOLD switch” on page 101.
- Change the automatic power-off time setting so that your CLIÉ handheld will automatically turn off after a short period of inactivity.
  - ➔ For details, refer to “Customizing your CLIÉ™ handheld (Preferences): Setting the automatic power-off time” in the supplied “Handbook”.

## Using peripheral devices

If a low battery warning is displayed while using peripheral devices, change your CLIÉ handheld immediately. If you continuously use it, it automatically turns off and cannot operate until you charge it.

## When the battery power gets low

- When the battery power gets low, a warning message is displayed on the screen, “Memory Stick” media becomes inaccessible, and the backlight adjustment no longer operates. If you continuously use your CLIÉ handheld, it automatically turns off and cannot be operated until you charge it. However, data or applications on your CLIÉ handheld will be automatically saved before the battery power is completely gone. In such a case, you can restore the data or applications after charging, by tapping [Yes] in the **Backup data** dialog box when your CLIÉ handheld turns on again.



- If your CLIÉ handheld does not turn on when you slide down the POWER/HOLD switch, charge your CLIÉ handheld immediately.
- The remaining battery indicator may not always reflect the actual battery power. To prevent loss of battery power, charge your CLIÉ handheld frequently.
- You do not have to replace batteries. When battery power gets low, connect your CLIÉ handheld to charger cradle and start charging immediately. Never disassemble your CLIÉ handheld to take out the battery.

## Other information

Your CLIÉ handheld may get warm if turned on for long periods of time. This is not a malfunction.

## Recycling Lithium-Ion batteries

The following information for recycling batteries is ONLY intended for customers in the U.S.A. and Canada.

Lithium-Ion batteries are recyclable.

You can help preserve our environment by returning your used rechargeable batteries to the collection and recycling location nearest you.

For more information regarding recycling of rechargeable batteries, call toll free 1-800-822-8837, or visit the website (<http://www.rbrc.org/>).

When you dispose of your CLIÉ handheld, remove the battery for recycling.

## How to remove a rechargeable button battery

### Note

Remove the battery only when you dispose of your CLIÉ handheld.

- 1** Remove the screw from the side of your CLIÉ handheld with a Phillips screwdriver.
- 2** Remove the battery cover.

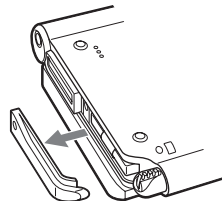
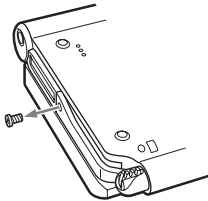

- 3** Pull the ribbon attached to the battery.
- 4** Take out the battery by pulling the ribbon.

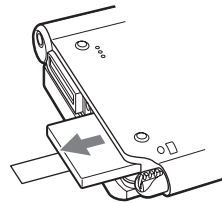
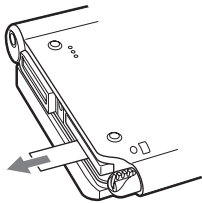

Do not damage the removed battery.

# Specifications

## OS

Palm OS® 5 (Ver.5.2)

## CPU

Sony CDX2230GA

## Memory

Total 104 MB

User memory available:

CLiÉ handheld Approx. 16 MB

Internal Media Approx. 29MB

## External input/output

USB

IrDA (1.2)

Bluetooth®

Wireless LAN (IEEE802.11b) for  
PEG-UX50 only

“Memory Stick” slot

## Display

TFT color display with backlight,  
480 × 320 dots, 65,536 colors

## Other functions

Monaural Speaker

Monaural Microphone

Headphone: Stereo mini-jack

Jog Dial™ navigator

BACK button

## Dimensions (excluding projections)

Approx. 4 1/8 × 3 1/2 × 23/32 inches  
(103 × 86.5 × 17.9 mm) (w/h/d)

## Weight

Approx. 6 oz (175 g)  
(including the supplied stylus)

## Operating temperature

41 °F to 95 °F (5 °C to 35 °C)

## Audio frequency response

20 Hz to 20,000 Hz

## Audio recording format

ATRAC3

MP3 (32 k~320 kbps)

## Sampling frequency

32 kHz (MP3)

44.1 kHz (ATRAC3, MP3)

48 kHz (MP3)

## Maximum recording time

ATRAC3 format

(when using a 128MB “MagicGate  
Memory Stick” media, sold  
separately):

Approx. 120 minutes  
(bit rate: 132 kbps)

Approx. 160 minutes  
(bit rate: 105 kbps)

Approx. 240 minutes  
(bit rate: 66 kbps)

MP3 format

(when using a 128MB “Memory  
Stick” media, sold separately):

Approx. 65 minutes  
(bit rate: 256 kbps)

Approx. 130 minutes  
(bit rate: 128 kbps)

Approx. 170 minutes  
(bit rate: 96 kbps)

## Voice encoding/decoding format

IMA ADPCM (1ch, 4bit)  
SP mode (22 kHz),  
LP mode (8 kHz)

## Maximum audio recording time

(when using a 128MB “Memory Stick” media, sold separately)  
SP mode: Approx. 190 minutes  
LP mode: Approx. 520 minutes

## Output

Headphone: Stereo mini-jack

## Power requirements

AC power adapter (supplied):  
DC 5.2 V (dedicated connector)  
(Use an appropriate AC cord from the supplied AC cords)

Battery:  
Lithium-ion battery

## Battery life

Operating PIMs (Personal Information Management applications):  
Approx. 9 days  
(when PIMs, such as **Date Book**, are operated for 30 minutes per day with the backlight off)  
Approx. 5 days  
(when PIMs, such as **Date Book**, are operated for 30 minutes per day with the backlight on\*)  
Approx. 14 days  
(in Power Saving Mode)  
(when PIMs, such as **Date Book**, are operated for 30 minutes per day with the backlight off and your CLIE handheld is turned off in Power Saving Mode)

Playing audio files continuously:  
Approx. 16 hours  
(when playing audio files in HOLD mode)  
Approx. 3 hours  
(when playing audio files not in HOLD mode and the backlight on\*)

Recording movie files continuously:  
Approx. 1 hour  
(when recording movie files not in HOLD mode and the backlight on\*)

Viewing movie files continuously:  
Approx. 5 hours  
(when viewing movie files with the backlight off)  
Approx. 2.5 hours  
(when viewing movie files with the backlight on\*)

Recording voice memos continuously:  
Approx. 11 hours  
(when recording voice memos in HOLD mode)  
Approx. 3 hours  
(when recording voice memos not in HOLD mode and the backlight on\*)

Performing data communication continuously with the Bluetooth® function:  
Approx. 3 hours  
(when performing data communication with the backlight on\*)

Performing data communication continuously with the wireless LAN function, for PEG-UX50 only:  
Approx. 2.5 hours  
(when performing data communication with the backlight on\*)

Battery power charge varies depending on the temperature and conditions of use.

\* The brightness level of the backlight is at the highest when the backlight is on.

.....

## Camera

### Effective pixels

Approx. 310,000 pixels

### Image pickup device

$\frac{1}{5.5}$  inch scan CMOS image sensor

### Lens

F2.8/focal length 2.6 mm  
(35 mm film equivalent  
f=approx. 34.3 mm)

### Focus range

AF = 0.3 m to  $\infty$

### Camera Rotating Angle

Capable recording angle:  
Approx. 240°  
Camera lens angle:  
Approx. 300°

### Camera finder

On the CLIE handheld display  
Image file: 320 × 240,  
160 × 240 dots  
Movie file: 320 × 224 dots

## Others

White Balance:

Auto, Indoor A (incandescent light), Indoor B (fluorescent light),  
Outdoor

Picture effect:

Off, B&W, Sepia, Neg. Art  
(negative art), Solarization

Brightness Control:

-2 to +2

Self-timer function:

Approx. 10 seconds (for image files only)

### Picture size (when recording)

Image file: 640 × 480, 320 × 480  
(vertical frame), 320 ×  
240, 160 × 120 dots

Movie file: 160 × 112 dots

### Formats (when recording)

Image file: JPEG (DCF) format  
Movie file: Movie Player format

### Picture size (when viewing)

On the CLIE handheld display  
Image file: 320 × 480, 320 × 240,  
160 × 120 dots  
Movie file: 426 × 320, 320 × 240  
160 × 112 dots

### Formats (when viewing)

Image file: JPEG (DCF) format  
Movie file: Movie Player format,  
MPEG Movie format

## Maximum movie recording time

(when using a 128MB “Memory Stick” media, sold separately)

Note that the maximum movie recording time in continuous operation is approx. 60 minutes.

V:256/A: 32kbps :

Approx. 60 minutes

V:192/A: 32kbps :

Approx. 70 minutes

V:96/A: 32kbps :

Approx. 120 minutes

## Maximum image file recording capacity

(when using a 128MB “Memory Stick” media sold separately)

640 × 480 dots: Approx. 1,000 files

320 × 480 dots: Approx. 1,500 files

320 × 240 dots: Approx. 2,000 files

160 × 120 dots: Approx. 6,000 files

Your CLIE handheld supports “Memory Stick” media, “MagicGate Memory Stick” media, “Memory Stick Duo” media, and “Memory Stick PRO” media. Note that data requiring the MagicGate function cannot be viewed or recorded with “Memory Stick PRO” media.

## Bluetooth® function

### Communication method

Bluetooth® standard Ver.1.1

### Output

Bluetooth® standard Power Class 2

### Communication range <sup>1)</sup>

Line of sight approx. 10 m

### Supported Bluetooth® profiles <sup>2)</sup>

Serial Port Profile

Dial-up Networking Profile

LAN Access Profile

Object Push Profile

Basic Imaging Profile

### Frequency band

2.4 GHz band

(2.4000 GHz - 2.4835 GHz)

<sup>1)</sup> The actual range will vary depending on factors such as obstacles between devices, magnetic fields around a microwave oven, static electricity, areas with heavy radio and/or magnetic interference, radio wave conditions, reception sensitivity or antenna performance, and the operating system or software application, etc.

<sup>2)</sup> Bluetooth® standard profiles specify the requirements of the protocol software and application software for Bluetooth® devices to communicate with each other.



.....

## Wireless LAN function (for PEG- UX50 only)

### Applied standard

IEEE 802.11b

### Frequency band

2.4GHz band (1~11ch, ISM band)

### WEP(data encryption)

64,128 bits\*

### Modulation method

DS-SS(in conformity to IEEE  
802.11b)

\*The maximum key length available for entry is 40 bits (5 alphanumeric characters) for the 64-bit length and 104 bits (13 alphanumeric characters) for the 128-bit length.

.....

## System requirements

The following are the system specifications required to run **Palm™ Desktop for CLIE** and software supplied on the Installation CD-ROM:

- OS:  
Microsoft Windows 98 Second Edition,  
Windows Millennium Edition,  
Windows 2000 Professional,  
Windows XP Home Edition,  
Windows XP Professional
- CPU: Pentium II 400MHz or faster (Pentium III 500MHz or faster is recommended)

- RAM: 96MB or more (128MB or more is recommended, 256MB or more is recommended for Windows XP)
- Hard disk drive space: 200MB or more (350MB or more is recommended)\*
  - \* Requires 100MB or more to print using **PictureGear Studio**.
- Display: High Color or better, 800 × 600 dots or more is recommended
- CD-ROM drive
- USB port
- Pointing device such as a mouse or touchpad

Design and specifications are subject to change without notice.

# CLIE™ handheld components

This chapter explains each part of your CLIE handheld and the supplied accessories.

## Front panel

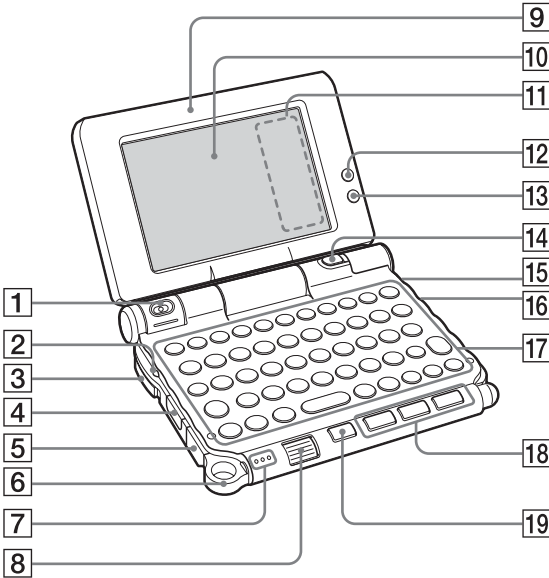

**1 Camera Lens**

(Pages 48, 50)

**2 POWER LED**

(Page 9)

Lights or blinks when turned on. The LED shows the status of your CLIÉ handheld by its color.

**Lights green:** The power is on. (It also lights in HOLD mode)

**Blinks green:** Blinks a few moments when you operate any button on your CLIÉ handheld in HOLD mode.

**Lights orange:** The battery is being charged.

**Blinks orange:** Alarm function that notifies you at a preset time if you have set an alarm in an application, such as **Date Book**.

**OFF:** The power is off.

**3 POWER/HOLD Switch**

(Pages 11, 101)

Turns your CLIÉ handheld on and off, and sets your CLIÉ handheld to HOLD mode.

**4 IR Port**

(Page 103)

You can beam data between your CLIÉ handheld and another CLIÉ handheld or Palm OS® PDA.

**5 USB connector**

(Page 19)

For connecting the supplied USB cable.

**6 Strap Ring**

**7 Microphone**

(Page 53)

Use this to record sounds.

**8 Jog Dial™ navigator**

(Page 26)

Use to select and run applications or items. Depending on the application, unique features are assigned.

**9 Display Panel**

(Page 9)

**10 Screen**

(Page 106)

**11 Silk Screen Area**

(Page 108)

**12 Wireless LAN LED  
(for PEG-UX50 only)**

(Page 42)

**13 Bluetooth LED**

(Page 68)

**14 CAPTURE/REC Button**

Press the CAPTURE/REC button to take pictures, record movies (Pages 48, 51) or to record voice memos (Page 53).

**15 REC LED**

(Page 53)

Lights when you are recording a movie or voice memo.

**16 "Memory Stick" LED**

(Page 102)

Blinks orange while your CLIÉ handheld is writing data to, or reading data from a "Memory Stick" media.

**17 Hardware Keyboard**

(Page 103)

**18 Application Buttons**

(Page 28)

Even when your CLIÉ handheld is turned off, pressing an application button turns on your CLIÉ handheld and starts that application.

**19 BACK Button**

Cancels the selection of an item or an operation. Depending on the application, unique features such as restoring to the previous screen are assigned.

# Back panel

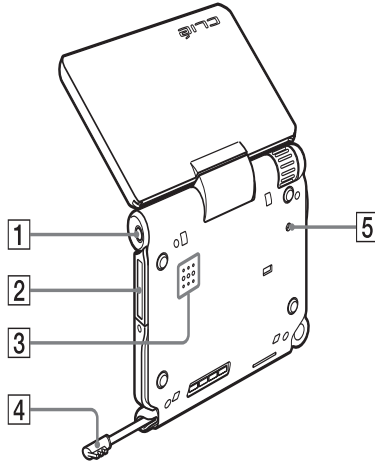

**1 Headphone Jack**

For connecting stereo mini-jack headphones sold separately.

**2 "Memory Stick" Slot**

(Page 102)

Insert a "Memory Stick" media into this slot.

**3 Speaker**

**4 Stylus**

(Page 11)

A pointed tool to operate your CLIÉ handheld by touching the screen with it.

**5 RESET Button**

(Pages 32, 33)

Press to restart your CLIÉ handheld.

.....

## POWER/HOLD switch

### ■ Turning on/off your CLIÉ handheld

#### Slide down the POWER/HOLD switch

The POWER/HOLD switch will return to the center position after being released. Your CLIÉ handheld powers on, the last screen viewed is displayed, and the POWER LED lights green. To turn off your CLIÉ handheld, slide down the POWER/HOLD switch again and then release.

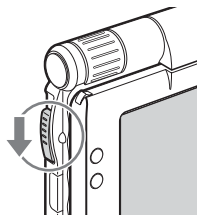

POWER/HOLD Switch

### ■ Turning on/off the LCD backlight

Slide down the POWER/HOLD switch and hold it for more than two seconds.

### ■ Turning on/off the HOLD mode

#### Slide up the POWER/HOLD switch

Putting your CLIÉ handheld in HOLD mode deactivates the touch screen. If you put the POWER/HOLD switch into the HOLD position while the power is on, the screen display turns off, even during an operation. To release the HOLD mode, slide up the POWER/HOLD switch again and then release.

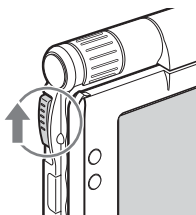

# Using “Memory Stick” media

## Inserting “Memory Stick” media

The “Memory Stick” LED blinks orange while your CLIÉ handheld is writing data to, or reading data from a “Memory Stick” media.

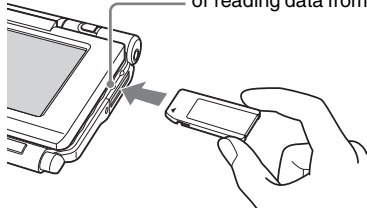

### Note

Insert a “Memory Stick” media in the right direction. If you forcibly insert a “Memory Stick” media in the wrong direction, the “Memory Stick” slot may be damaged.

## Removing “Memory Stick” media

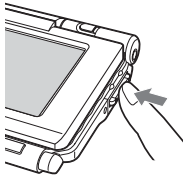

Push “Memory Stick” media in

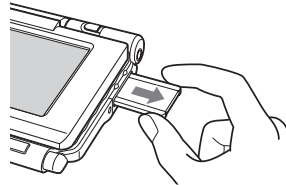

Pull “Memory Stick” media out

### Note

Make sure that your CLIÉ handheld is not writing files/data to, or reading files/data from, a “Memory Stick” media before removing it. (The “Memory Stick” LED blinks when it is reading or writing files/data.) If you remove a “Memory Stick” media while the “Memory Stick” LED is blinking, recorded files/data may be deleted or damaged.

## IR port

You can beam data or applications between your CLIÉ handheld and another CLIÉ handheld or Palm OS® PDA.

► For details, refer to “Beaming” in the supplied “Handbook”.

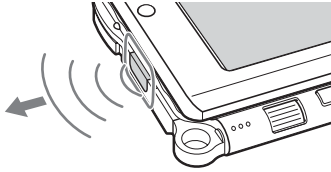

\* Move your CLIÉ handheld gradually to find the most sensitive direction.

## Hardware Keyboard

You can use the hardware keyboard in the same way as you would use the keyboard of your computer.

For details about the key arrangement, check your CLIÉ handheld.

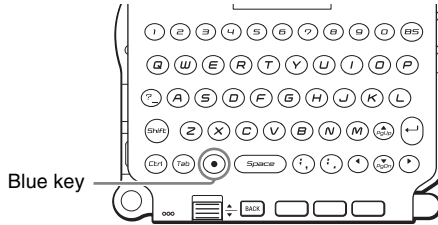

### Input commands

You can perform commands using the hardware keys in combination.

### Key combinations

Example: Ctrl + C → Hold down the Ctrl key and press the character C key.

### Basic operations

Combination	Function
⊕ (Blue) + blue character	To type the characters in blue. To type them continuously, press ⊕ (Blue) twice to lock, and press it again to unlock.
Shift	To type capital letters. To type capital letters continuously, press the Shift key twice to lock the caps, and press it again to unlock.

Continued on next page

## Edit

Combination	Function
<b>Ctrl + C</b>	To copy the selected text.
<b>Ctrl + D</b>	To delete the selected text.
<b>Ctrl + V</b>	To paste the selected text.
<b>Ctrl + X</b>	To cut the selected text.
<b>Ctrl + U(Z)</b>	To undo text editing.
<b>Ctrl + ►/◀</b>	To select one word to the right/left.
<b>Shift + ►/◀</b>	To select a continuing/preceding text.

## Functions

Combination	Function
<b>Ctrl + G</b>	To show/hide the silk screen area.
<b>Ctrl + H</b>	To go to the Home screen (the CLIE 3D Launcher or Palm OS® Standard screen).
<b>Ctrl + L</b>	To turn the backlight on/off.
<b>Ctrl + M</b>	To display the menu.
<b>Ctrl + O</b>	To go to the previous field.
<b>Ctrl + P</b>	To go to the next field.
<b>Ctrl + R</b>	To perform a full-screen pen stroke.*

\* You can change this function by selecting **Preferences** and tapping [Buttons] - [Pen].

## Dialogs

Combination	Function
<b>Ctrl + A</b>	To display the <b>Adjust Volume</b> dialog box.
<b>Ctrl + B</b>	To display the <b>Battery Information</b> dialog box.
<b>Ctrl + E</b>	To display the <b>Media Info</b> dialog box.
<b>Ctrl + F</b>	To display the <b>Find</b> dialog box.
<b>Ctrl + K</b>	To display the <b>Keyboard Help</b> screen.
<b>Ctrl + T</b>	To display the command tool bar.



## Button operations

Combination	Function
Ctrl + ▲/▼	Same as Jog Dial Up/Down.
Ctrl + Enter	Same as pressing Jog Dial.
Ctrl + Enter (Long Push)	Same as holding down the Jog Dial.
Ctrl + BS	Same as pressing the BACK button.
Ctrl + BS (Long Push)	Same as holding down the BACK button.

## More

Combination	Function
Ctrl + Ⓞ (Blue) + S	To turn off your CLIÉ handheld using Power Saving Mode.

### Tip

When you use a Palm OS® application that assigns a function to the scroll buttons, the same function can be performed by using a key combination, Ⓞ (Blue) + ▲/▼.

# Locating the components of the CLIE 3D Launcher

## Tip

If a different screen is displayed, tap  (Home).

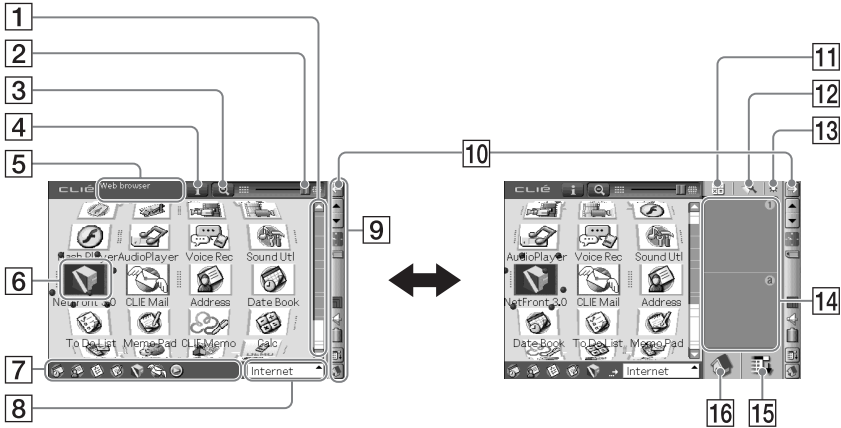

### 1 Scroll bar

### 2 3D Adjust bar

Scroll the bar with the stylus to adjust the 3D degree.

### 3 Zoom In/Out icon

Tap to change application icons to small or large.

### 4 Information icon

Tap to display the information for a selected application icon.

### 5 Application Summary area

Description of a selected application is displayed here

### 6 Application icons

### 7 Favorite Applications (shortcuts)

You can create shortcuts to favorite applications.

### 8 CLIE 3D Launcher groups list

The list of CLIE 3D Launcher groups is displayed.

### 9 Status bar

(page 108)

### 10 Resize icon

If you tap this icon, the screen view will be switched.

### 11 Calculator

Tap to display the on-screen Calculator.

### 12 Find icon

Tap to display the dialog box finding data or applications.

### 13 Brightness Adjustment icon

Tap to display the dialog box for adjusting brightness.

**14 Graffiti 2 writing area**

Write strokes of **Graffiti 2** here.  
**Decuma Input** can be launched from this area.

For details, refer to “Entering text on your CLIE™ handheld: Using Decuma Input to enter text” in the supplied “Handbook”.

**15 Menu icon**

Tap to display menu of the current application.

**16 Home icon**

Tap to display the CLIE 3D Launcher or Palm OS® Standard screen.

.....

## Status Bar

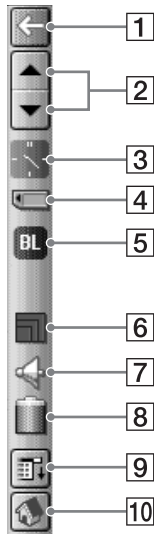

The status bar displays the following icons. Additional icons will be displayed according to the applications in use.







- 
- 1  Tap this icon to show or hide the silk screen area.

---

  - 2  Tap of scroll up/down the screen or select items of an application in use.

---

  - 3  Displays the current time. To change the display format, select **Preferences**, and tap [Formats]-[Time].
    - For details, refer to “Customizing your CLIÉ™ handheld (Preferences): Setting up the Date & Time preferences” in the supplied “Handbook”.
-





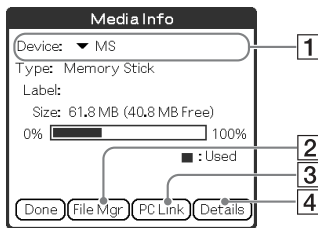

- 
- 4  Each icon indicates the information on the “Memory Stick” media inserted into your CLIÉ handheld.
-  “Memory Stick” media is inserted.
  -  “Memory Stick” media is not inserted.
  -  “Memory Stick” media is write-protected.
  -  “Memory Stick” media is not read correctly.
  -  “Memory Stick” media is reading.
  -  A “Memory Stick” compatible device is inserted.





Tap the icon to display the **Media Info** dialog box when “Memory Stick” media is inserted.



- 1 **Media type**  
You can choose another device by tapping ▼ next to [Device:].
- 2 Tap to display **CLIE Files**.
- 3 Tap to display **Data Import**.
- 4 Tap to display the **Device Detail** dialog box for information on the device or driver.

From the **Media Info** dialog box, tap  (Menu) and then tap [Preferences] from [Option] to select operations for “Memory Stick” media.

- 
- 5  Displayed when  (Blue) is pressed while an application such as **Date Book** is open.  will be displayed when  (Blue) is pressed twice to lock. Also,  is displayed when the Shift key is pressed, and  will be displayed when it is pressed twice to lock the caps.  
➔ For details, refer to “Hardware Keyboard” on page 103.

- 
- 6  Displays the reception level for the wireless LAN when your CLIÉ handheld is connected to the wireless LAN (for PEG-UX50 only). The reception levels are:  (level 1),  (level 2), and  (level 3)
-

7  Tap to display the **Adjust Volume** dialog box.

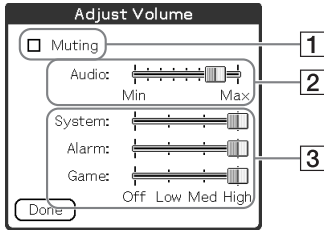



1 Turns off the sound of your CLIE™ handheld.

When Muting mode is selected,  is displayed in the status bar.

2 Adjusts the volume level for playing back audio files or movie files.

3 Adjusts the volume level for System sound, Alarm sound, and Game sound. This affects the [General] settings in **Preferences**.

➔ For details, refer to “Customizing your CLIE™ handheld (Preferences): Setting sounds” in the supplied “Handbook.”

8  Displays the battery’s remaining charge.  is displayed while the battery is connected to outside power sources.

Tap to display the **Battery Information** dialog box.

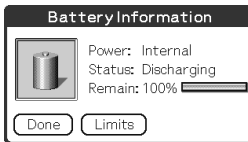



Power: Power used

Status: Battery status

Remain: Remaining charge of the battery

Tap [Limits] to display the **Battery Limits** dialog box.

9  Tap to display the menus of the current application.

10  Tap to display the CLIE 3D Launcher or Palm OS® Standard screen.

### Tip

**When a dialog box or screen such as the below is displayed**

Tap the  icon to display tips and helpful advice.



# Locating Charger Cradle components

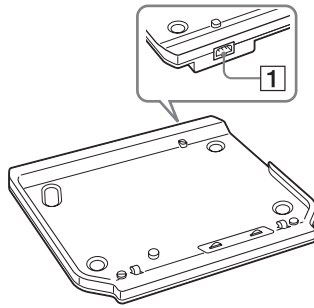

## **1 AC Power Adapter Connector**

(Page 8)

# INDEX

---

## A

---

- AC power adapter . . . . . 6, 8
- Address Book . . . . . 61, 81
- Applications
  - Quitting . . . . . 27
  - Starting. . . . . 25
  - Using the CLIÉ Application Manual . . 72
- Audio Player . . . . . 58, 79

---

## B

---

- Backup . . . . . 85
- Basic Operations. . . . . 24
- Battery considerations . . . . . 90
- Bluetooth® function . . . . . 66

---

## C

---

- Calculator . . . . . 82
- Carrying style . . . . . 9
- Charger Cradle . . . . . 8, 111
- CLIÉ 3D Launcher . . . . . 106
- CLIÉ Album . . . . . 56, 75
- CLIÉ Camera . . . . . 74
- CLIÉ Files . . . . . 83
- CLIÉ Mail . . . . . 80
- CLIÉ Memo . . . . . 82
- CLIÉ Viewer . . . . . 55, 74
- Components . . . . . 98

---

## D

---

- Data Export. . . . . 65, 84
- Data Import . . . . . 65, 84
- Date Book. . . . . 59, 81
- Decuma Input . . . . . 29
- Display panel . . . . . 9

---

## E

---

- Entering text . . . . . 29
- Exchanging Date Book and Address Book data . . . . . 63

---

## G

---

- Giga Pocket Plugin . . . . . 78
- Graffiti® 2. . . . . 29

---

## H

---

- Hardware keyboard. . . . . 103
- Have a try
  - Exchanging Date Book and Address Book data between your CLIÉ handheld and computer. . . . . 63
  - Listening to music . . . . . 57
  - Managing addresses and telephone numbers . . . . . 61
  - Managing schedule events . . . . . 59
  - Recording a voice memo . . . . . 53
  - Using the Bluetooth® function . . . . 66
  - Viewing computer documents on your CLIÉ handheld . . . . . 64
  - Viewing handwritten memos and image files, and playing back voice memos. . 55
- HotSync® operation . . . . . 21

---

## I

---

- Image Converter . . . . . 76
- Image Files
  - Enjoying . . . . . 49
  - Taking pictures. . . . . 47
- Initial setup. . . . . 9
- Input commands. . . . . 103
- Intellisync Lite . . . . . 17, 84
- IR port. . . . . 103



---

**M**

---

Macromedia Flash Player 5 . . . . .	78
Managing addresses and telephone numbers . . . . .	61
Managing schedule events . . . . .	59
Memo Pad . . . . .	81
"Memory Stick" LED . . . . .	102
"Memory Stick" Slot . . . . .	102
Movie Player . . . . .	77
Movie Recorder . . . . .	77
Movies	
Enjoying . . . . .	52
Recording movies . . . . .	50

---

**N**

---

NetFront v3.0 for CLIE . . . . .	80
----------------------------------	----

---

**O**

---

Opened style . . . . .	9
Operating style . . . . .	9

---

**P**

---

Palm™ Desktop for CLIE . . . . .	16
Photo Editor . . . . .	56, 76
PhotoStand . . . . .	56, 75
Picxel Viewer for CLIE . . . . .	64, 83
PictureGear Studio . . . . .	76
Playing back music data . . . . .	58
Power Saving Mode . . . . .	30

---

**R**

---

Recording a voice memo . . . . .	53
Remote Camera . . . . .	75
Restarting	
Hard reset . . . . .	33
Soft reset . . . . .	32

---

**S**

---

Set date . . . . .	13
Set time . . . . .	13
Setting up . . . . .	8
SMS . . . . .	82
SonicStage . . . . .	57, 80
Sound Utility . . . . .	79
Specifications . . . . .	93
Status bar . . . . .	108
Stylus . . . . .	11

---

**T**

---

Tapping . . . . .	12
Time zone . . . . .	14
To Do List . . . . .	81
Turned style . . . . .	10

---

**U**

---

USB cable . . . . .	19
USB port . . . . .	19
Using applications . . . . .	72

---

**V**

---

Viewing computer documents . . . . .	64
Voice Recorder . . . . .	53, 79

---

**W**

---

wireless LAN function . . . . .	35
World Alarm Clock . . . . .	83



## **On the trademarks**

Before using your CLIÉ handheld, be sure to read the accompanying End-User's License Agreement.

Sony, CLIÉ, "Memory Stick", "Memory Stick Duo", "Memory Stick PRO", "MagicGate Memory Stick", Jog Dial, PictureGear Studio and their logos are trademarks of Sony Corporation.

Palm, Palm Powered, the Palm logo, the Palm Powered logo, Palm OS, Graffiti, HotSync and the HotSync logo are trademarks of PalmSource, Inc.

Graffiti 2 powered by Jot®.

Microsoft and Windows are registered trademarks of Microsoft Corporation.

Pentium is registered trademarks of Intel Corporation.

Intellisync is a trademark of Pumatech, Inc.

Adobe and Acrobat are trademarks of Adobe Systems Incorporated.

QuickTime and the QuickTime logo are trademarks of Apple Computer, Inc.

NetFront is a trademark of ACCESS CO, Ltd.

Picstel and the Picstel logo are trademarks of Picstel Technologies, Ltd.

Contains Macromedia® Flash™ Player software by Macromedia, Inc.  
Copyright © 1995-2003 Macromedia, Inc.

Macromedia and Flash are trademarks or registered trademarks of Macromedia, Inc. in the United States and internationally.

Decuma is a trademark of Decuma AB in the United States and other countries.

This product includes fonts owned by TypeBank Co., Ltd. under license.

Bluetooth is a registered trademark that is owned by the proprietor and used by Sony under license.

All other trademarks are trademarks of their respective owners.

For the latest information on support  
and accessories,  
check our official Sony CLIE website

For customers in the U.S.A. and Canada

**<http://www.sony.com/clie/>**

For customers in Australia, Hong Kong, Malaysia,  
Mexico, New Zealand, Singapore, Taiwan and Thailand

**<http://vaio-online.sony.com/clie/>**